

# XW2F

## Accelerate Reductions in Factory Wiring and Labor with Screwless Terminals.

- Clamp terminals eliminate the need to tighten screws.
- Just insert the ferrule to complete one-touch wiring.

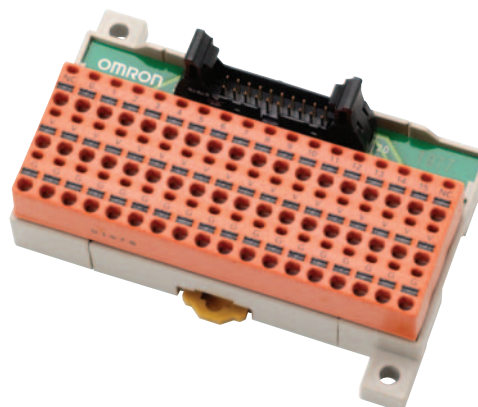

## Ordering Information

### Connector-Terminal Block Conversion Units

Number of input/outputs	Number of contacts	I/O	Common Terminals	Model	Mounted Connector model	Cable Connector model
16	20	Inputs	YES	XW2F-20G7-IN16	XG4A-2031	XG4M-2030-T
16	20	Outputs	YES	XW2F-20G7-OUT16	XG4A-2031	XG4M-2030-T

### Accessories (Order Separately)

#### Connecting Cables for Connector-Terminal Block Conversion Units

Refer to the *XW2Z datasheet*.

## Ratings and Specifications

<b>Rated current</b>		1 A/point, 4 A/common
<b>Rated voltage</b>		24 VDC
<b>Insulation resistance</b>		100 MΩ min. (at 500 VDC)
<b>Dielectric strength</b>		500 VAC for 1 min
<b>Ambient operating temperature</b>		-10 to 55°C
<b>Applicable wires</b>	<b>Applicable wire sizes</b>	AWG24 to AWG14 (core cross-sectional area: 0.21 to 2.08 mm <sup>2</sup> ) Outer diameter of insulation must be 3.6 mm max.
	<b>Stripped length</b>	AWG24 to 16: 9 to 11 mm, AWG14: 10.5 to 11.5 mm

## Dimensions

### XW2F-20G7-IN16, XW2F-20G7-OUT16

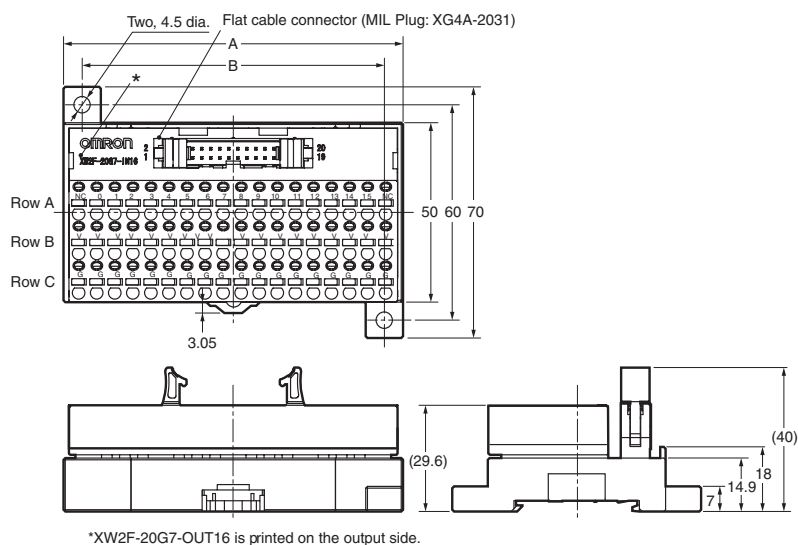

### Wiring Diagram

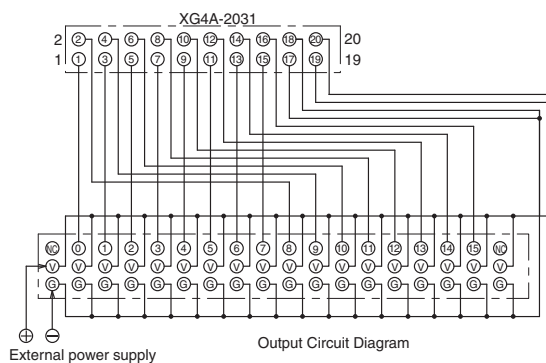
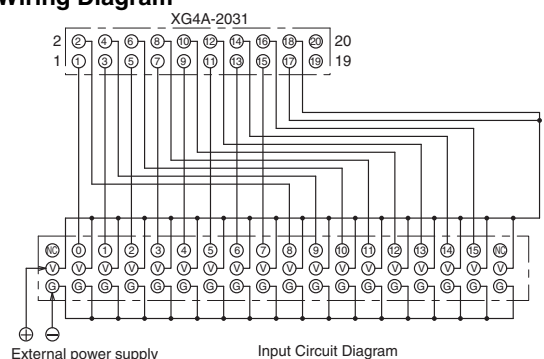

### Dimensions

Model	Number of contacts	Dimension A (mm)	Dimension B (mm)
XW2F-20G7-IN16 XW2F-20G7-OUT16	20	95.5	85

### Input Terminal Block XW2F-20G7-IN16 (Orange)

Row A	NC	0	1	2	3	4	5	6	7	8	9	10	11	12	13	14	15	NC	
Row B	V	V	V	V	V	V	V	V	V	V	V	V	V	V	V	V	V	V	V
Row C	G	G	G	G	G	G	G	G	G	G	G	G	G	G	G	G	G	G	G

### Output Terminal Block XW2F-20G7-OUT16 (Yellow)

Row A	NC	0	1	2	3	4	5	6	7	8	9	10	11	12	13	14	15	NC	
Row B	V	V	V	V	V	V	V	V	V	V	V	V	V	V	V	V	V	V	V
Row C	G	G	G	G	G	G	G	G	G	G	G	G	G	G	G	G	G	G	G

## Safety Precautions

### Precautions for Correct Use

#### ● Wiring Precautions

- Do not perform wiring work, remove connectors, or connect connectors while power is being supplied. Electric shock or damage to the device may result.
- Double-check all wiring before turning ON the power supply.
- After wiring, confirm that the cable is connected.
- After wiring, route the cable so that force is not applied directly to the connections.
- Insert only one wire in each wire insertion opening. It may not be possible to remove the wires if more than one wire is inserted.
- Do not apply a current higher than the rated value. Be sure to check the rated current, which depends on the model of the cable.

#### ● Wires for Terminal Blocks

- Do not damage the cores when stripping the insulation from them.
- Always twist stranded wires together before connecting them.
- Do not presolder wires. It may not be possible to connect them or remove them.

#### ● Mounting to and Removing from DIN Track

- When mounting the Unit to a DIN Track, release the lock on the slider, mount the Unit to DIN Track, and then lock the slider back in place.
- After locking the slider, confirm that the Unit is actually locked on the DIN Track.
- When removing the Unit from a DIN Track, insert a screwdriver into the slider, release the lock, and remove the Unit from the DIN Track.
- Always secure the Unit(s) on the DIN Track by mounting End Plates on either end. The following products are sold separately.

DIN Track	PFP-50N PFP-100N
DIN Track	PFP-M

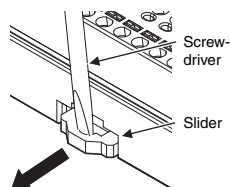

#### ● Applicable Ferrules

- Use ferrules of the lengths and thicknesses specified below. If other lengths or thicknesses are used, connection may not be possible or it may not be possible to insert or remove the posts.

Square ferrules

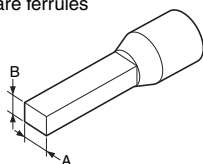

Round ferrules

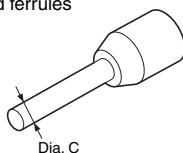

Square ferrules	Dimension A	1.0 to 2.3	The cross-sectional area after crimping must be 4.8 mm <sup>2</sup> or less
	Dimension B	0.8 to 2.65	
Round ferrules	Dimension C	0.8 to 2.3 dia.	

#### ● Recommended Ferrules and Crimp Tools

Type of ferrule	Manufacturer	Size	Ferrule model	Recommended crimp tool
Square ferrules	Phoenix Contact	AWG24	AI0.25-8YE	UD6 ZA3
		AWG22	AI0.34-8TQ	
		AWG20	AI0.5-10WH AI0.5-8WH	
		AWG18	AI0.75-10GY AI0.75-8GY	
		AWG16	AI1.5-10BK	
	Nihon Wielder Muller	AWG24	H0.25/12	PZ6 roto
		AWG22	H0.34/12	
		AWG20	H0.5/16 H0.5/14	
AWG18		H0.75/16 H0.75/14		
Round ferrules	Nichifu	AWG22	TGV TC-1.25-11T TGN TC-1.25-11T	NH11 NH21 NH65
		AWG20		
		AWG18		
		AWG16		

#### ● Wiring Terminal Blocks

- Insert wires as follows:  
Stranded wires: Press in on the lever with a flat-blade screwdriver (1). Insert the wire (2).
- Solid wires or ferrules: Insert the wire/post to the back of the wire insertion opening. (The lever does not need to be used.)
- Remove the wire using the following procedure. (This procedure can be used for twisted wire, solid wire, or ferrules.) Press in on the lever with a flat-blade screwdriver (1). Remove the wire (3).

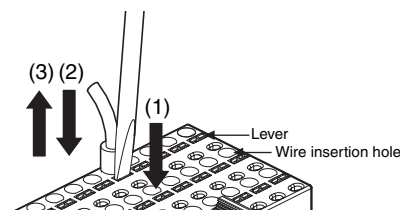

- To operate the lever, use a flat-blade screwdriver with a fixed thickness from the tip to the base of the screwdriver, as specified below.

Side	Front	Dimension D	0.3 to 0.8
		Dimension E	2.9 to 3.6

OMRON provides the following flat-blade screwdrivers for use in operating the lever.

#### Recommended Flat-blade Screwdrivers

Model
XW4Z-00B
XW4Z-00C

## Terms and Conditions Agreement

### Read and understand this catalog.

Please read and understand this catalog before purchasing the products. Please consult your OMRON representative if you have any questions or comments.

### Warranties.

(a) Exclusive Warranty. Omron's exclusive warranty is that the Products will be free from defects in materials and workmanship for a period of twelve months from the date of sale by Omron (or such other period expressed in writing by Omron). Omron disclaims all other warranties, express or implied.

(b) Limitations. OMRON MAKES NO WARRANTY OR REPRESENTATION, EXPRESS OR IMPLIED, ABOUT NON-INFRINGEMENT, MERCHANTABILITY OR FITNESS FOR A PARTICULAR PURPOSE OF THE PRODUCTS. BUYER ACKNOWLEDGES THAT IT ALONE HAS DETERMINED THAT THE PRODUCTS WILL SUITABLY MEET THE REQUIREMENTS OF THEIR INTENDED USE.

Omron further disclaims all warranties and responsibility of any type for claims or expenses based on infringement by the Products or otherwise of any intellectual property right. (c) Buyer Remedy. Omron's sole obligation hereunder shall be, at Omron's election, to (i) replace (in the form originally shipped with Buyer responsible for labor charges for removal or replacement thereof) the non-complying Product, (ii) repair the non-complying Product, or (iii) repay or credit Buyer an amount equal to the purchase price of the non-complying Product; provided that in no event shall Omron be responsible for warranty, repair, indemnity or any other claims or expenses regarding the Products unless Omron's analysis confirms that the Products were properly handled, stored, installed and maintained and not subject to contamination, abuse, misuse or inappropriate modification. Return of any Products by Buyer must be approved in writing by Omron before shipment. Omron Companies shall not be liable for the suitability or unsuitability or the results from the use of Products in combination with any electrical or electronic components, circuits, system assemblies or any other materials or substances or environments. Any advice, recommendations or information given orally or in writing, are not to be construed as an amendment or addition to the above warranty.

See <http://www.omron.com/global/> or contact your Omron representative for published information.

### Limitation on Liability; Etc.

OMRON COMPANIES SHALL NOT BE LIABLE FOR SPECIAL, INDIRECT, INCIDENTAL, OR CONSEQUENTIAL DAMAGES, LOSS OF PROFITS OR PRODUCTION OR COMMERCIAL LOSS IN ANY WAY CONNECTED WITH THE PRODUCTS, WHETHER SUCH CLAIM IS BASED IN CONTRACT, WARRANTY, NEGLIGENCE OR STRICT LIABILITY.

Further, in no event shall liability of Omron Companies exceed the individual price of the Product on which liability is asserted.

### Suitability of Use.

Omron Companies shall not be responsible for conformity with any standards, codes or regulations which apply to the combination of the Product in the Buyer's application or use of the Product. At Buyer's request, Omron will provide applicable third party certification documents identifying ratings and limitations of use which apply to the Product. This information by itself is not sufficient for a complete determination of the suitability of the Product in combination with the end product, machine, system, or other application or use. Buyer shall be solely responsible for determining appropriateness of the particular Product with respect to Buyer's application, product or system. Buyer shall take application responsibility in all cases.

NEVER USE THE PRODUCT FOR AN APPLICATION INVOLVING SERIOUS RISK TO LIFE OR PROPERTY OR IN LARGE QUANTITIES WITHOUT ENSURING THAT THE SYSTEM AS A WHOLE HAS BEEN DESIGNED TO ADDRESS THE RISKS, AND THAT THE OMRON PRODUCT(S) IS PROPERLY RATED AND INSTALLED FOR THE INTENDED USE WITHIN THE OVERALL EQUIPMENT OR SYSTEM.

### Programmable Products.

Omron Companies shall not be responsible for the user's programming of a programmable Product, or any consequence thereof.

### Performance Data.

Data presented in Omron Company websites, catalogs and other materials is provided as a guide for the user in determining suitability and does not constitute a warranty. It may represent the result of Omron's test conditions, and the user must correlate it to actual application requirements. Actual performance is subject to the Omron's Warranty and Limitations of Liability.

### Change in Specifications.

Product specifications and accessories may be changed at any time based on improvements and other reasons. It is our practice to change part numbers when published ratings or features are changed, or when significant construction changes are made. However, some specifications of the Product may be changed without any notice. When in doubt, special part numbers may be assigned to fix or establish key specifications for your application. Please consult with your Omron's representative at any time to confirm actual specifications of purchased Product.

### Errors and Omissions.

Information presented by Omron Companies has been checked and is believed to be accurate; however, no responsibility is assumed for clerical, typographical or proofreading errors or omissions.

2016.3

In the interest of product improvement, specifications are subject to change without notice.

**OMRON Corporation**  
Industrial Automation Company

<http://www.ia.omron.com/>

(c)Copyright OMRON Corporation 2016 All Right Reserved.