

XW2C-20G6-IO16

Common terminal provided. Use for either PLC Input Unit or Output Unit merely by changing short bar.

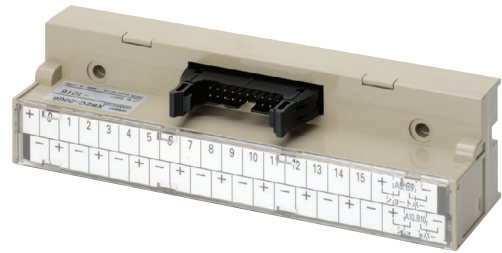

Ordering Information

Connector-Terminal Block Conversion Unit

No. of inputs	No. of poles	Model	Mounted Connector model	Cable Connector model
16	20	XW2C-20G6-IO16	XG4A-2031	XG4M-2030-T

Accessories (Order Separately)

Connecting Cables for Connector-Terminal Block Conversion Units

Refer to the *XW2Z datasheet*.

Ratings and Specifications

Rated current	1 A
Rated voltage	125 VAC, 24 VDC
Insulation resistance	100 MΩ min. (at 500 VDC)
Dielectric strength	500 VAC for 1 min (leakage current: 1 mA max.)
Ambient operating temperature	0 to 55°C

Dimensions

(Unit: mm)

XW2C-20G6-IO16

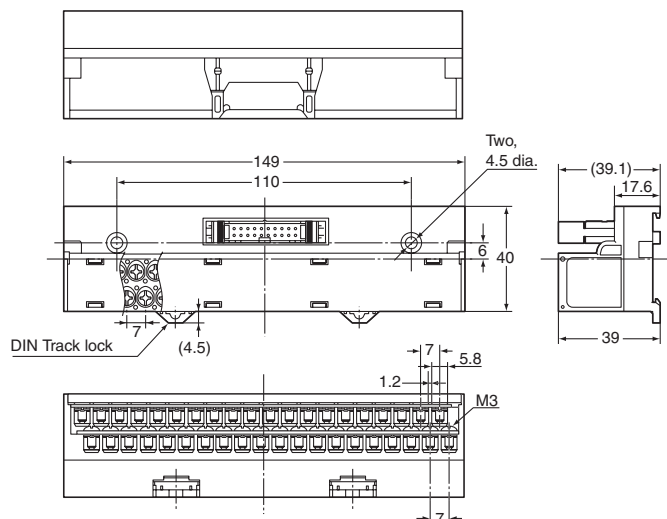
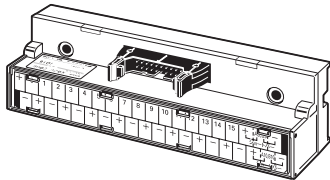

Wiring Diagram

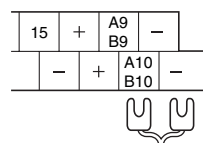
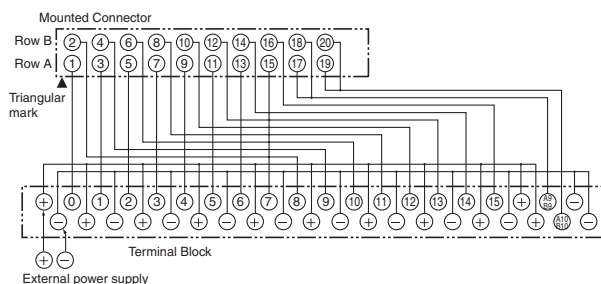

Connect the short bar according to the application as shown in the following table.

• Connecting to PLC I/O Unit

Application	Connection Method
NPN inputs (+ common)	Connect terminal A9/B9 and the positive power terminal. Terminal A10/B10 do not need to be connected.
PNP inputs (- common)	Connect terminal A9/B9 and the negative power terminal. Terminal A10/B10 do not need to be connected.
Outputs	Connect terminal A9/B9 and the negative power terminal. Terminal A10/B10 and the positive power terminal do not need to be connected.

• Connecting to Field Network Equipment

Application	Connection Method
NPN inputs PNP inputs	Connect terminal A9/B9 and the negative power terminal.
Outputs	Connect terminal A10/B10 and the positive power terminal.

Safety Precautions

Precautions for Correct Use

● Wiring

- Always turn OFF the power supply before wiring. Otherwise, cables or other conductors can short the terminals and cause the Unit to fail.
- Do not connect or disconnect Connectors with the power turned ON. Otherwise, it may cause malfunctions.

● Wiring Terminal Blocks

Using Crimp Terminals

(With a Terminal Block with M3 Screws)

Round crimp terminals

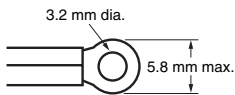

Forked crimp terminals



Applicable crimp terminals		Applicable wires
Round crimp terminals	1.25-3	AWG22 to AWG16 (0.30 to 1.25 mm ²)
Forked crimp terminals	1.25Y-3	AWG22 to AWG16 (0.30 to 1.25 mm ²)

● Terminal Screw Tightening Torque

Use a tightening torque of 0.7 N·m when connecting wires or crimp terminals to the terminal block.

● Mounting Units to and Removing Units from DIN Track

- XW2C Connector-Terminal Block Conversion Units can be mounted side-to-side on DIN Track.
- Secure both ends of the XW2C with End Plates.
- When removing the Unit from a DIN Track, insert a flat-head screwdriver into the slider and pull the lock out.

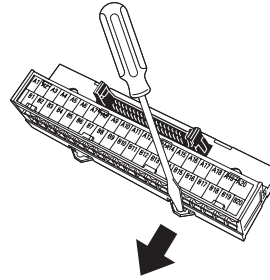

● Handling M3 Screw and Round Terminals

Raise the M3 screw with a Phillips screwdriver as shown in diagram (1) and slide the screw toward you to keep the space open. Follow the steps in diagrams (1) and (2) below when using round crimp terminals.

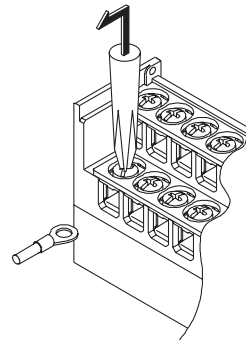

(1)

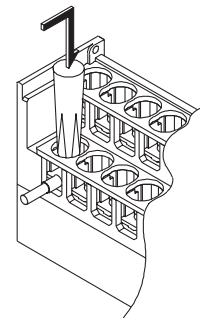

(2)

Read and Understand This Catalog

Please read and understand this catalog before purchasing the products. Please consult your OMRON representative if you have any questions or comments.

Warranty and Limitations of Liability

WARRANTY

OMRON's exclusive warranty is that the products are free from defects in materials and workmanship for a period of one year (or other period if specified) from date of sale by OMRON.

OMRON MAKES NO WARRANTY OR REPRESENTATION, EXPRESS OR IMPLIED, REGARDING NON-INFRINGEMENT, MERCHANTABILITY, OR FITNESS FOR PARTICULAR PURPOSE OF THE PRODUCTS. ANY BUYER OR USER ACKNOWLEDGES THAT THE BUYER OR USER ALONE HAS DETERMINED THAT THE PRODUCTS WILL SUITABLY MEET THE REQUIREMENTS OF THEIR INTENDED USE. OMRON DISCLAIMS ALL OTHER WARRANTIES, EXPRESS OR IMPLIED.

LIMITATIONS OF LIABILITY

OMRON SHALL NOT BE RESPONSIBLE FOR SPECIAL, INDIRECT, OR CONSEQUENTIAL DAMAGES, LOSS OF PROFITS OR COMMERCIAL LOSS IN ANY WAY CONNECTED WITH THE PRODUCTS, WHETHER SUCH CLAIM IS BASED ON CONTRACT, WARRANTY, NEGLIGENCE, OR STRICT LIABILITY.

In no event shall the responsibility of OMRON for any act exceed the individual price of the product on which liability is asserted.

IN NO EVENT SHALL OMRON BE RESPONSIBLE FOR WARRANTY, REPAIR, OR OTHER CLAIMS REGARDING THE PRODUCTS UNLESS OMRON'S ANALYSIS CONFIRMS THAT THE PRODUCTS WERE PROPERLY HANDLED, STORED, INSTALLED, AND MAINTAINED AND NOT SUBJECT TO CONTAMINATION, ABUSE, MISUSE, OR INAPPROPRIATE MODIFICATION OR REPAIR.

Application Considerations

SUITABILITY FOR USE

OMRON shall not be responsible for conformity with any standards, codes, or regulations that apply to the combination of products in the customer's application or use of the products.

At the customer's request, OMRON will provide applicable third party certification documents identifying ratings and limitations of use that apply to the products. This information by itself is not sufficient for a complete determination of the suitability of the products in combination with the end product, machine, system, or other application or use.

The following are some examples of applications for which particular attention must be given. This is not intended to be an exhaustive list of all possible uses of the products, nor is it intended to imply that the uses listed may be suitable for the products:

- Outdoor use, uses involving potential chemical contamination or electrical interference, or conditions or uses not described in this catalog.
- Nuclear energy control systems, combustion systems, railroad systems, aviation systems, medical equipment, amusement machines, vehicles, safety equipment, and installations subject to separate industry or government regulations.
- Systems, machines, and equipment that could present a risk to life or property.

Please know and observe all prohibitions of use applicable to the products.

NEVER USE THE PRODUCTS FOR AN APPLICATION INVOLVING SERIOUS RISK TO LIFE OR PROPERTY WITHOUT ENSURING THAT THE SYSTEM AS A WHOLE HAS BEEN DESIGNED TO ADDRESS THE RISKS, AND THAT THE OMRON PRODUCTS ARE PROPERLY RATED AND INSTALLED FOR THE INTENDED USE WITHIN THE OVERALL EQUIPMENT OR SYSTEM.

PROGRAMMABLE PRODUCTS

OMRON shall not be responsible for the user's programming of a programmable product, or any consequence thereof.

Disclaimers

CHANGE IN SPECIFICATIONS

Product specifications and accessories may be changed at any time based on improvements and other reasons.

It is our practice to change model numbers when published ratings or features are changed, or when significant construction changes are made. However, some specifications of the products may be changed without any notice. When in doubt, special model numbers may be assigned to fix or establish key specifications for your application on your request. Please consult with your OMRON representative at any time to confirm actual specifications of purchased products.

DIMENSIONS AND WEIGHTS

Dimensions and weights are nominal and are not to be used for manufacturing purposes, even when tolerances are shown.

PERFORMANCE DATA

Performance data given in this catalog is provided as a guide for the user in determining suitability and does not constitute a warranty. It may represent the result of OMRON's test conditions, and the users must correlate it to actual application requirements. Actual performance is subject to the OMRON Warranty and Limitations of Liability.

ERRORS AND OMISSIONS

The information in this document has been carefully checked and is believed to be accurate; however, no responsibility is assumed for clerical, typographical, or proofreading errors, or omissions.

2008.11

In the interest of product improvement, specifications are subject to change without notice.

OMRON Corporation
Industrial Automation Company

<http://www.ia.omron.com/>

(c)Copyright OMRON Corporation 2008 All Right Reserved.