

Direct Current Switch with Built-in Magnetic Blowout



- Incorporates a small permanent magnet in the contact mechanism to deflect the arc to effectively extinguish it.
- Same shape and mounting procedures as the Z Basic Switches.



 Be sure to read *Safety Precautions* on page 9 and *Safety Precautions for All Basic Switches*.

For the most recent information on models that have been certified for safety standards, refer to your OMRON website.

Model Number Structure

Model Number Legend

X-10G□-□
(1) (2)(3) (4)

(1) Ratings

10 : 10 A (125 VDC)

(2) Contact Gap

G : 0.9 mm

















(3) Actuator

- None : Pin plunger
- D : Short spring plunger
- S : Slim spring plunger
- Q : Panel mount plunger
- Q21 : Panel mount cross roller plunger
- Q22 : Panel mount roller plunger
- L : Leaf spring
- W : Hinge lever
- W2 : Hinge roller lever
- W21 : Short hinge lever
- W22 : Short hinge roller lever
- W4 : Low-force hinge lever
- M : Reverse hinge lever
- M2 : Reverse hinge roller lever
- M22 : Reverse short hinge roller lever

(4) Terminals

- None : Solder terminal
- B : Screw terminal (with toothed washer)

Ordering Information

Actuator	Terminal	Solder terminal 	Screw terminal 
		Model	Model
Pin plunger		X-10G	X-10G-B
Slim spring plunger		X-10GS	X-10GS-B
Short spring plunger		X-10GD	X-10GD-B
Panel mount plunger		X-10GQ	X-10GQ-B
Panel mount roller plunger		X-10GQ22	X-10GQ22-B
Panel mount cross roller plunger		X-10GQ21	X-10GQ21-B
Leaf spring		X-10GL	X-10GL-B
Short hinge lever		X-10GW21	X-10GW21-B
Hinge lever		X-10GW	X-10GW-B
Low-force hinge lever		X-10GW4	X-10GW4-B
Short hinge roller lever		X-10GW22	X-10GW22-B
Hinge roller lever		X-10GW2	X-10GW2-B
Reverse hinge lever		X-10GM	X-10GM-B
Reverse short hinge roller lever *		X-10GM22	X-10GM22-B
Reverse hinge roller lever *		X-10GM2	X-10GM2-B

* The plungers of reverse-type models are continuously pressed by the compression coil springs and the plungers are freed by operating the levers.

Specifications

Ratings

Rated voltage	Non-inductive load (A)				Inductive load (A)			
	Resistive load		Lamp load		Inductive load		Motor load	
	NC	NO	NC	NO	NC	NO	NC	NO
8 VDC	10		3	1.5	10	10	5	2.5
14 VDC	10		3	1.5	10	10	5	2.5
30 VDC	10		3	1.5	10	10	5	2.5
125 VDC	10		3	1.5	7.5	6	5	2.5
250 VDC	3		1.5	0.75	2	1.5	2	1.5

- Note: 1. The above values are for the steady-state current.
 2. Inductive load has a power factor of 0.4 min. (AC) and a time constant of 7 ms max. (DC).
 3. Lamp load has an inrush current of 10 times the steady-state current.
 4. Motor load has an inrush current of 6 times the steady-state current.
 5. The above electrical ratings also apply to the AC voltage.
 6. With the reverse-type models (X-10GM□), the normally closed circuits and normally open circuits are reversed.
 7. The ratings values apply under the following test conditions:
 (1) Ambient temperature: 20±2°C
 (2) Ambient humidity: 65±5%RH
 (3) Operating frequency: 20 operations/min

Certified Standard Ratings

Ask your OMRON representative for information on certified models.

UL/CSA

Rated voltage	Model	X-10G
125 VDC		10 A
250 VDC		3 A

EN (CE) (Conform to EN61058-1)

Rated voltage	Model	X-10
125 VDC		10 A

Characteristics

Operating speed		0.1 mm to 1 m/s *1
Operating frequency	Mechanical	240 operations/min
	Electrical	20 operations/min
Insulation resistance		100 MΩ min. (at 500 VDC)
Contact resistance		15 mΩ max. (initial value)
Dielectric strength		1,500 VAC, 50/60 Hz for 1 min between terminals of the same polarity, between current-carrying metal parts and the ground, and between each terminal and non-current-carrying metal parts
Vibration resistance	Malfunction	10 to 55 Hz, 1.5-mm double amplitude *2
Shock resistance	Destruction	1,000 m/s ² max.
	Malfunction	300 m/s ² max. *1 *2
Durability	Mechanical	1,000,000 operations min.
	Electrical	100,000 operations min.
Degree of protection		IP00
Degree of protection against electric shock		Class I
Proof tracking index (PTI)		175
Ambient operating temperature		-25°C to 80°C (with no icing)
Ambient operating humidity		35% to 85%RH
Weight		Approx. 27 to 63 g

*1. The values are for the pin plunger models. (Contact your OMRON representative for other models.)

*2. Malfunction: 1 ms max.

Structure

Contact Form (SPDT)



Note: With the reverse-type models (X-10GM□), the NC and NO terminal arrangements are reversed.

Contact Specification

Contacts	Material	Silver
	Gap (standard value)	0.9 mm
Inrush current	NC	30 A max.
	NO	15 A max.

Engineering Data

Mechanical Durability (X-10G)

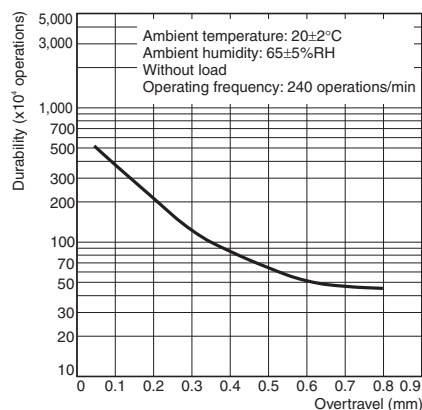

Electrical Durability (X-10G)

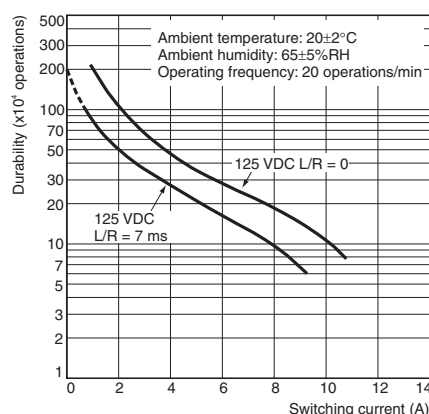

Dimensions

(Unit: mm)

Terminals

Screw Terminals (-B)

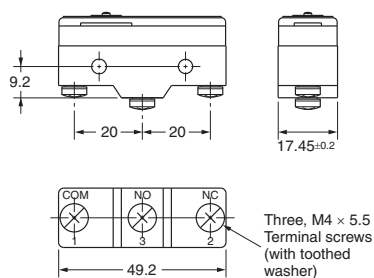

Solder Terminal (-A) ("A" is not included in the model numbers.)

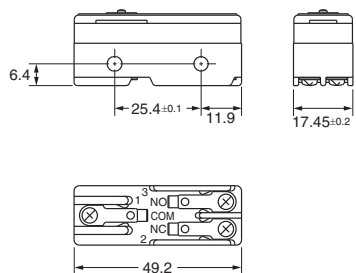

- Note: 1. Tighten the terminal screws to a torque of 0.78 to 1.18 N-m.
 2. Unless otherwise specified, a tolerance of ± 0.4 mm applies to all dimensions.
 3. In case of DC voltage, set the COM to the positive terminal.

Mounting

Use M4 mounting screws with plane washers or spring washers to securely mount the Switch. Tighten the screws to a torque of 1.18 to 1.47 N-m.

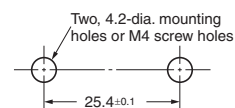

The Switch can be panel mounted, provided that the hexagonal nut of the actuator is tightened to a torque of 2.94 to 4.9 N-m.

Panel Mount Plunger

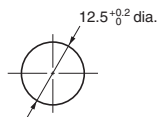

Panel Mount Roller Plunger

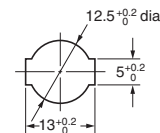

Dimensions and Operating Characteristics

The models, illustrations, and graphics are for screw-terminal models. (The dimensions for models that are omitted here are the same as for pin-plunger models.)

Pin Plunger X-10G-B

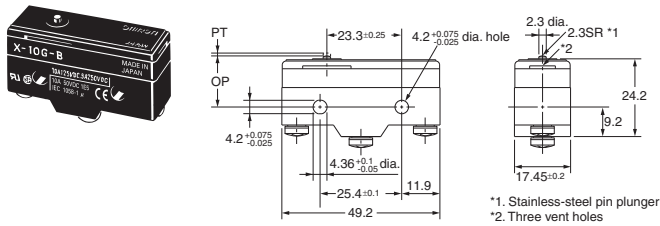

Slim Spring Plunger X-10GS-B

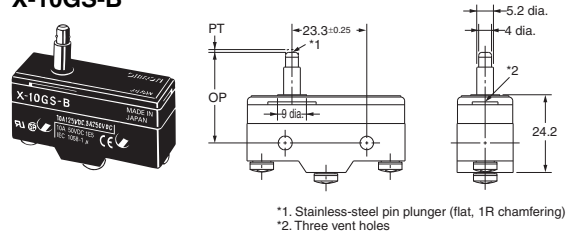

Short Spring Plunger X-10GD-B

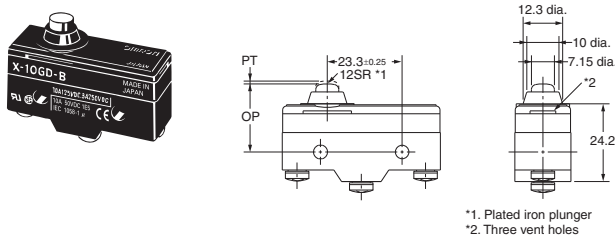

Panel Mount Plunger X-10GQ-B

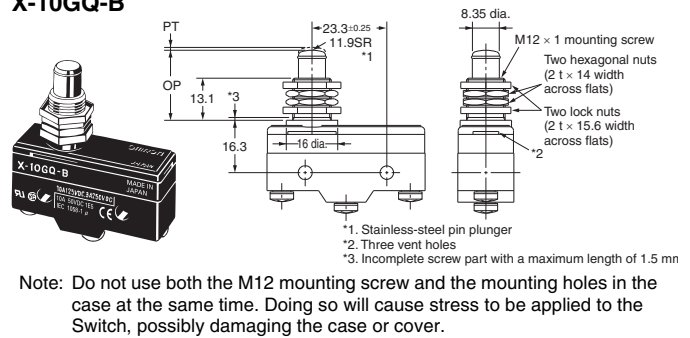

Panel Mount Roller Plunger X-10GQ22-B

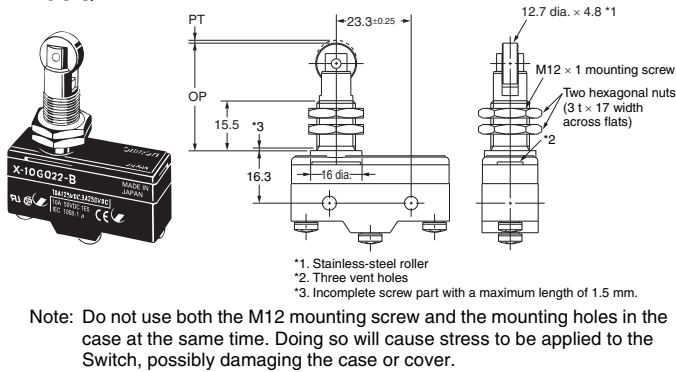

Panel Mount Cross Roller Plunger X-10GQ21-B

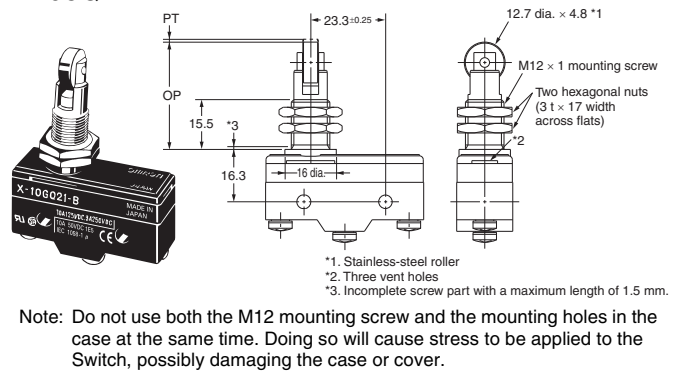

Leaf Spring X-10GL-B

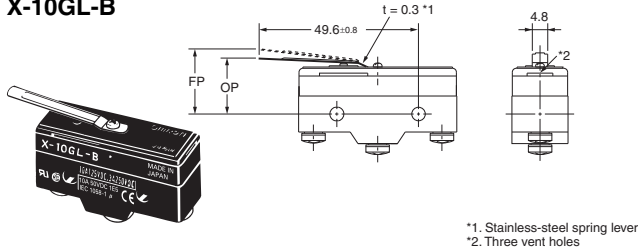

Note: Unless otherwise specified, a tolerance of ± 0.4 mm applies to all dimensions.

Operating Characteristics	Model	X-10G-B	X-10GS-B	X-10GD-B	X-10GQ-B	X-10GQ22-B	X-10GQ21-B	X-10GL-B
Operating force	OF max.	5.00 N	5.00 N	5.00 N	5.00 N	5.00 N	5.00 N	1.96 N
Release force	RF min.	1.12 N	1.12 N	1.12 N	1.12 N	1.12 N	1.12 N	0.14 N
Pretravel	PT max.	0.9 mm	0.9 mm	0.9 mm	0.9 mm	0.9 mm	0.9 mm	—
Overtravel	OT min.	0.13 mm	1.6 mm	1.6 mm	5.5 mm	3.6 mm	3.6 mm	1.6 mm *
Movement Differential	MD max.	0.18 mm	0.18 mm	0.18 mm	0.18 mm	0.18 mm	0.18 mm	2.3 mm
Free Position	FP max.	—	—	—	—	—	—	22.1 mm
Operating Position	OP	15.9±0.4 mm	28.2±0.5 mm	21.2±0.5 mm	21.8±0.8 mm	33.4±1.2 mm	33.4±1.2 mm	17.4±0.8 mm

* Be sure to use the switch at the rated OT value of 1.6 mm.

Short Hinge Lever
X-10GW21-B

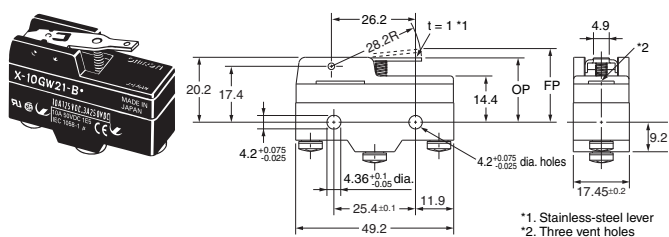

Hinge Lever
X-10GW-B

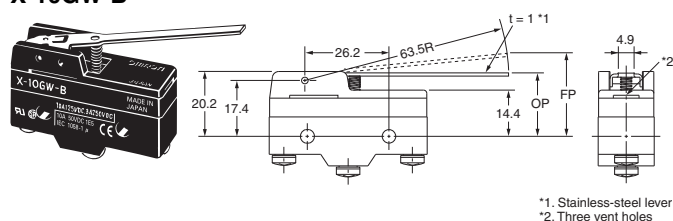

Low-force Hinge Lever
X-10GW4-B

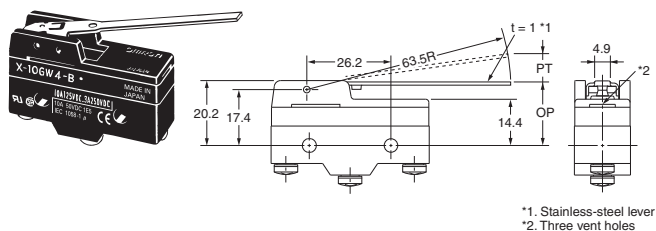

Short Hinge Roller Lever
X-10GW22-B

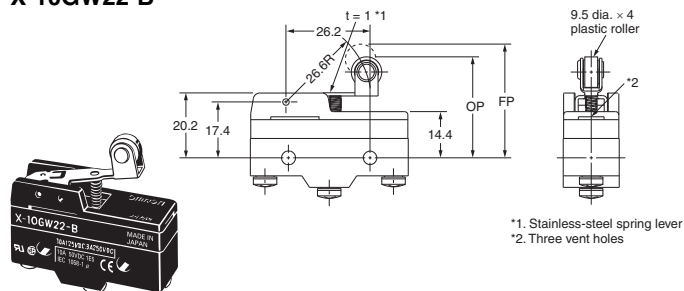

Hinge Roller Lever
X-10GW2-B

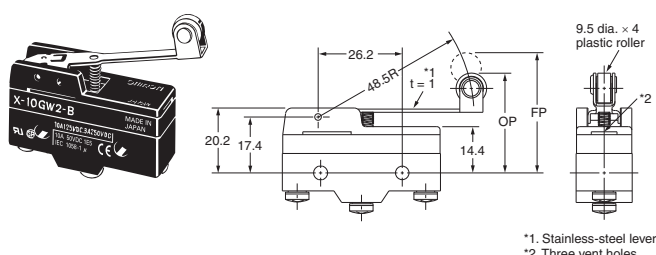

Reverse Hinge Lever
X-10GM-B

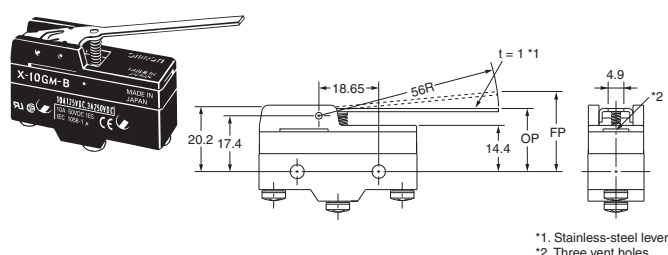

Reverse Short Hinge Lever
X-10GM22-B

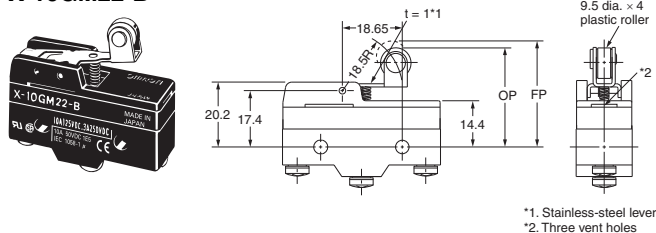

Reverse Hinge Roller Lever
X-10GM2-B

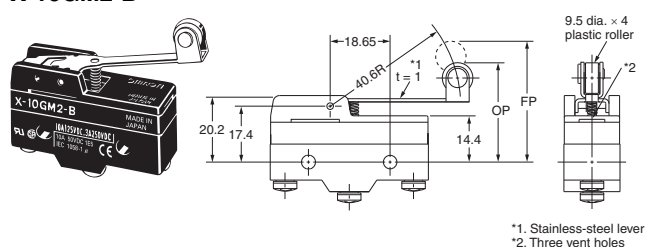

Note: Unless otherwise specified, a tolerance of ± 0.4 mm applies to all dimensions.

Model		X-10GW21-B	X-10GW-B	X-10GW4-B	X-10GW22-B	X-10GW2-B	X-10GM-B	X-10GM22-B	X-10GM2-B
Operating Characteristics	OF	max. 2.45 N	1.08 N	0.25 N	2.16 N	1.42 N	2.16 N	6.86 N	3.14 N
	RF	min. 0.31 N	0.14 N	0.05 N	0.34 N	0.21 N	0.25 N	1.52 N	0.49 N
	PT	max. —	—	14.3 mm	—	—	—	—	—
	OT	min. 2.1 mm	4.8 mm	4.8 mm	2.4 mm	4 mm	5.5 mm	2 mm	4 mm
	MD	max. 1.7 mm	3.9 mm	3.9 mm	1.7 mm	3 mm	2.1 mm	0.75 mm	1.5 mm
FP	max. 25.5 mm	34.6 mm	—	37.1 mm	40.5 mm	26.8 mm	36.1 mm	37.4 mm	
OP	20.7 \pm 0.8 mm	21.1 \pm 0.8 mm	21.1 \pm 0.8 mm	32.2 \pm 0.8 mm	32.2 \pm 0.8 mm	21.1 \pm 0.8 mm	32.2 \pm 0.8 mm	32.2 \pm 0.8 mm	

Accessories (Order separately)

A Terminal Protective Cover, Actuators, and a Separator are available.

Terminal Covers (Sold Separately)

The Terminal Covers can be attached to Z, A, X, and DZ Switches. The Terminal Cover is secured with mounting screws and protects the casing and terminal wires from dust, vibration, or fingers, thus preventing terminal short-circuiting, ground faults, wire disconnection or improper connection, and electric shock accidents. Terminal Covers made of phenol resin have five or six thin wall sections. These sections can be torn open for providing holes for lead cables at desired points. A terminal cover can't be used in the case of using an actuator sold separately.

Operation Information

Material	Application Mounting direction	Soldering terminal use	Screw terminal use	Remarks
		Model		
Phenol resin	Side mounting	AP-A	AP-B	---
Metal press mold	Side mounting	AP1-A	AP1-B	Used for AP-A and AP-B
Vinyl chloride	Side mounting	AP-Z		---

Note: Use a Terminal Cover for screw terminals for DZ-series Switches with soldering terminals.

Separator (Sold Separately)

Use a Separator when it is difficult to provide a sufficient insulation distance or when using the Switch near metal parts or copper wires.

Operation Information

Model
SEPARATOR FOR Z

Dimensions (Unit: mm)

Terminal Covers

AP-A
Soldering Terminal Use
(Phenol Resin)

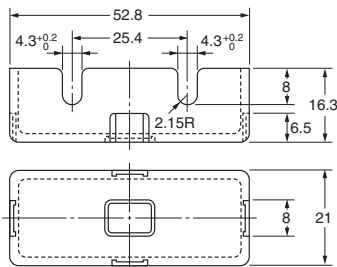
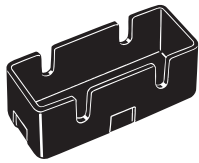

Note: The Cover has five thin, easy-to-separate portions for easy lead wire connections.

AP-B
Screw Terminal Use
(Phenol Resin)

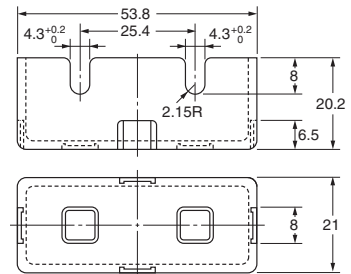
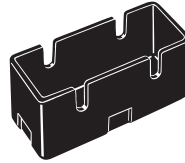

Note: The Cover has six thin, easy-to-separate portions for easy lead wire connections.

AP1-A
Soldering Terminal Use
(Metal Press Mold)

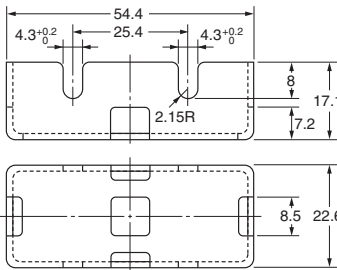
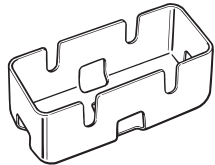

Note: The Cover has five holes for easy lead wire connections.

AP1-B
Screw Terminal Use
(Metal Press Mold)

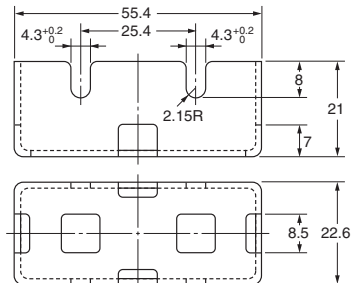
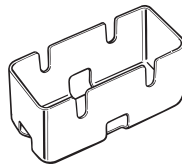

Note: The Cover has six holes for easy lead wire connections.

AP-Z
Soldering or Screw Terminal Use
(Vinyl Chloride)

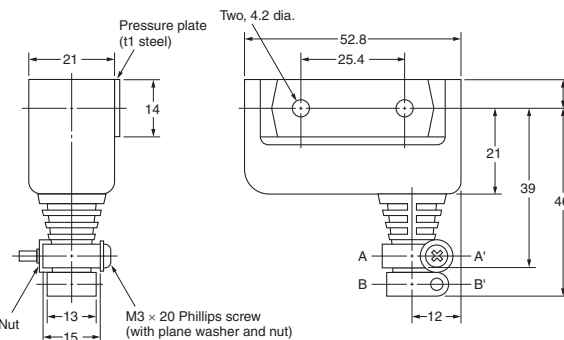
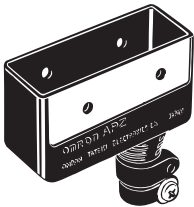

Cable Pull-out Dimension

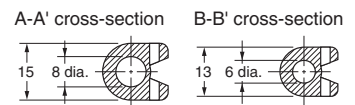

Note: A 6-dia. or 8-dia. cable can be used by cutting the cable pull-out hole to the size of the cable to be used.

Note: Each dimension has a tolerance of ± 0.4 mm unless otherwise specified. (± 0.8 mm for the AP-Z)

Separator

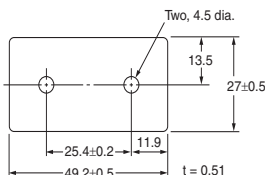



Note: 1. Each dimension has a tolerance of ± 0.4 mm unless otherwise specified.
2. The material is EAVTC (Epoxy Alkyd Varnished Teflon Cloth) and its heat-resisting temperature is 130°C.

Actuators (Sold Separately)

A Switch can be actuated by a cam or an appropriate object, in which case, use one of the following Actuators according to the application.

Ordering Information

Actuator	Application	Common to Z and X models
Hinge lever		XAA-1
Hinge roller lever		ZAA-2
Panel mount plunger	Short	ZAQ-3
	Medium	ZAQ-2
	Long	ZAQ-1
Panel mount roller plunger		ZAQ-22

Dimensions (Unit: mm) and Operating Characteristics

Note: These Actuators are not provided with Switches.

**Hinge Lever
XAA-1**

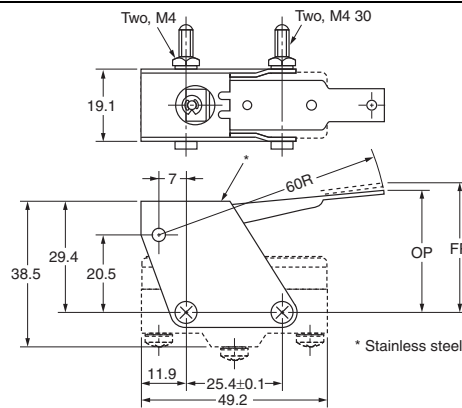
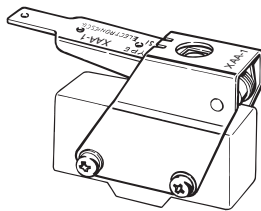

Model		Z-15G-B	X-10G-B
Operating characteristics	Operating force OF max.	4.90 N	4.90 N
	Release force RF min.	1.67 N	1.67 N
	Overtravel OT min.	12.7 mm	12.7 mm
	Movement Differential MD max.	2.2 mm	3.3 mm
Free Position FP max.	32.9±1.6 mm		
Operating Position OP	28.9±1.6 mm		

Note: This Actuator can be used with the Z-15G(-B) and X-10G(-B). When mounting the Switch, set the overtravel to between 32% and 100%, taking into consideration the operating body and the distance between the Actuator and the dog.

**Hinge Roller Lever
ZAA-2**

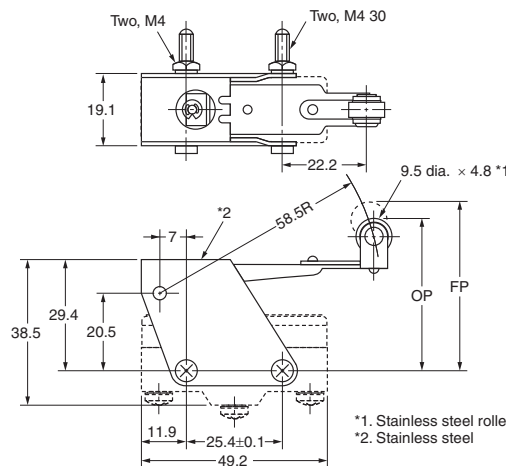
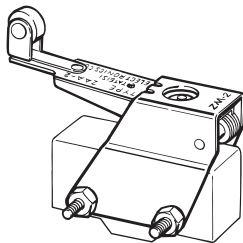

	Z-15G-B	X-10G-B
OF max.	4.90 N	4.90 N
RF min.	1.67 N	1.67 N
OT min.	12.7 mm	12.7 mm
MD max.	2.2 mm	3.3 mm
FP max.	44.5±1.6 mm	
OP	40.4±1.6 mm	

Note: This Actuator can be used with the Z-15G(-B) and ZX-10G(-B). When mounting the Switch, set the overtravel to between 32% and 100%, taking into consideration the operating body and the distance between the Actuator and the dog.

**Short Panel Mount Plunger
ZAQ-3**

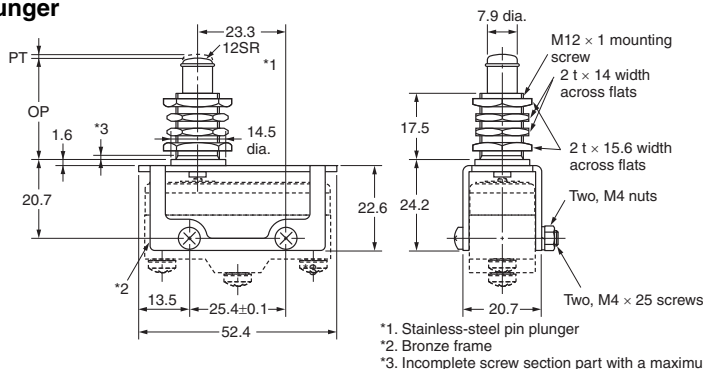
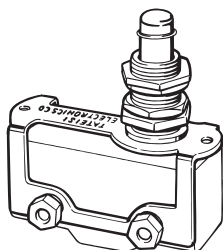

	ZAQ-3	
	Z-15E-B	X-10G-B
OF max.	8.34 N	5.39 N
RF min.	1.12 N	1.12 N
PT max.	0.8 mm	1 mm
OT min.	4.8 mm	4.5 mm
MD max.	0.15 mm	0.2 mm
OP	27.8±1.5 mm	

Note: 1. This Actuator (pin plunger) can be used with Standard Pin Plungers (Z-15G(-B), Z-15E(-B), X-10G(-B), DZ-10G-1A(-1B)) for the Z, X, and DZ models.

Note: Each dimension has a tolerance of ±0.4 mm unless otherwise specified.

Medium Panel Mount Plunger
ZAQ-2

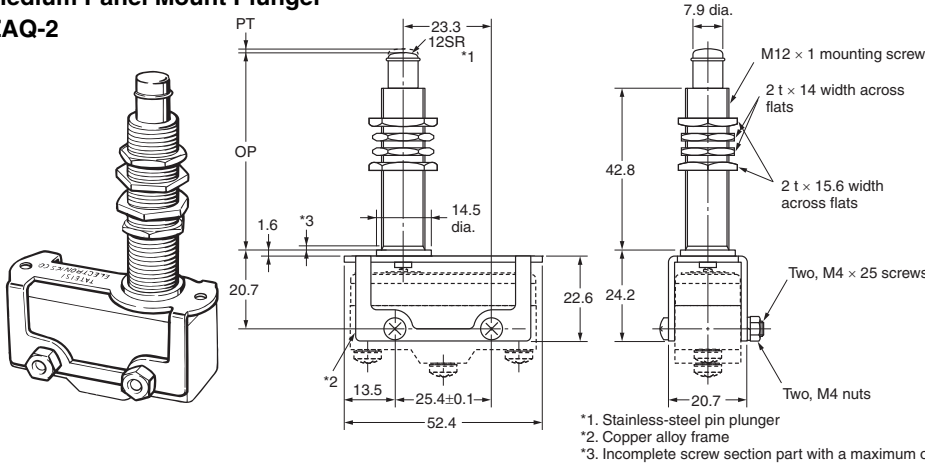

	ZAQ-2	
	Z-15E-B	X-10G-B
OF max.	8.34 N	5.39 N
RF min.	1.12 N	1.12 N
PT max.	0.8 mm	1 mm
OT min.	4.8 mm	4.5 mm
MD max.	0.15 mm	0.2 mm
OP	53.2±1.5 mm	

Note: This Actuator (pin plunger) can be used with Standard Pin Plungers (Z-15G(-B), Z-15E(-B), X-10G(-B), DZ-10G-1A(-1B)) for the Z, X, and DZ models.

Long Panel Mount Plunger
ZAQ-1

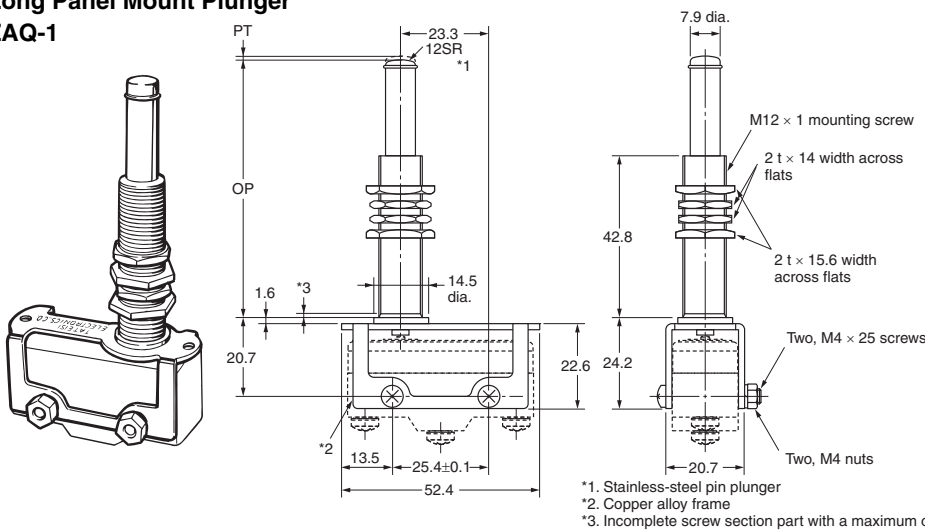

	ZAQ-1	
	Z-15E-B	X-10G-B
OF max.	8.34 N	5.39 N
RF min.	1.12 N	1.12 N
PT max.	0.8 mm	1 mm
OT min.	20.6 mm	20.4 mm
MD max.	0.15 mm	0.2 mm
OP	69.1±1.5 mm	

Note: This Actuator (pin plunger) can be used with Standard Pin Plungers (Z-15G(-B), Z-15E(-B), X-10G(-B), DZ-10G-1A(-1B)) for the Z, X, and DZ models.

Panel Mount Roller Plunger
ZAQ-22

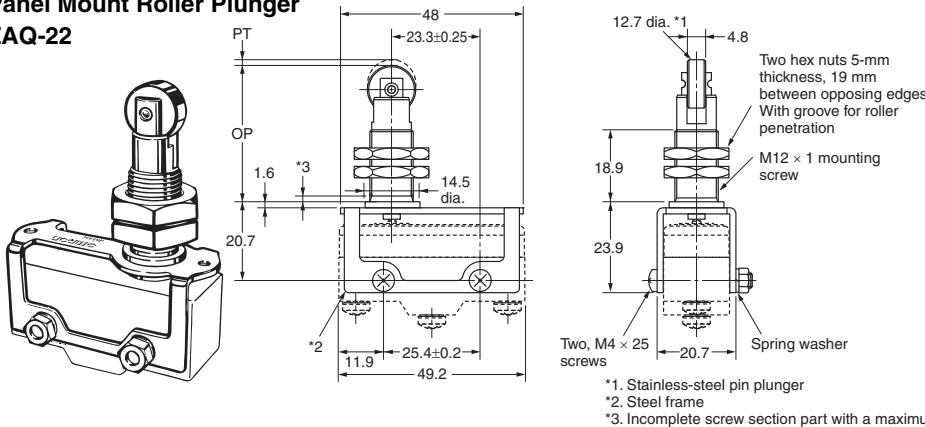

	ZAQ-22	
	Z-15E-B	DZ-10G-1B
OF max.	8.34 N	11.1 N
RF min.	1.12 N	1.12 N
PT max.	2 mm	2 mm
OT min.	3.58 mm	1 mm
MD max.	0.15 mm	0.46 mm
OP	37±0.8 mm	35.4±1.2 mm

Note: This Actuator (roller plunger) can be used with standard pin plungers (Z-15G(-B), Z-15E(-B), and DZ-10G-1A(-1B)). It cannot be used with X models.

Note: Each dimension has a tolerance of ±0.4 mm unless otherwise specified.

Safety Precautions

Refer to *Safety Precautions for All Basic Switches*.

Precautions for Safe Use

Terminal Connection

When soldering lead wires to the Switch, make sure that the capacity of the soldering iron is 60 W maximum. Do not take more than 5 s to solder any part of the Switch. The characteristics of the Switch will deteriorate if a soldering iron with a capacity of more than 60 W is applied to any part of the Switch for 5 s or more.

Operation

- Make sure that the switching frequency or speed is within the specified range.
 - If the switching speed is extremely slow, the contact may not be switched smoothly, which may result in a contact failure or contact welding.
 - If the switching speed is extremely fast, switching shock may damage the Switch soon. If the switching frequency is too high, the contact may not catch up with the speed.

The rated permissible switching speed and frequency indicate the switching reliability of the Switch.
The life of a Switch is determined at the specified switching speed. The life varies with the switching speed and frequency even when they are within the permissible ranges. In order to determine the life of a Switch model to be applied to a particular use, it is best to conduct an appropriate durability test on some samples of the model under actual conditions.
- Make sure that the actuator travel does not exceed the permissible OT position. The operating stroke must be set to 70% to 100% of the rated OT.

Precautions for Correct Use

Mounting Location

- Do not use the switch alone in atmospheres such as flammable or explosive gases. Arcing and heat generation associated with switching may cause fires or explosions.
- Switches are generally not constructed with resistance against water. Use a protective cover to prevent direct spraying if the switch is used in locations subject to splashing or spurling oil or water, dust adhering.

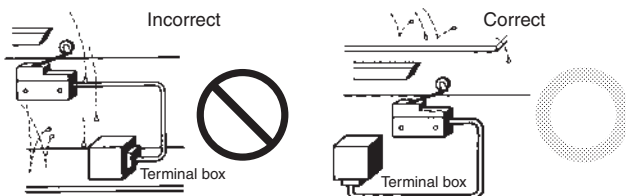

- Install the switch in a location that is not directly subject to debris and dust from cutting. The actuator and the switch body must be protected from accumulated cutting debris and dirt.



- Do not use the switch in locations subject to hot water (greater than 60°C) or in water vapor.
- Do not use the switch outside the specified temperature and atmospheric conditions. The permissible ambient temperature depends on the model. (Refer to the specifications in this catalog.) Sudden thermal changes may cause thermal shock to distort the switch and result in faults.

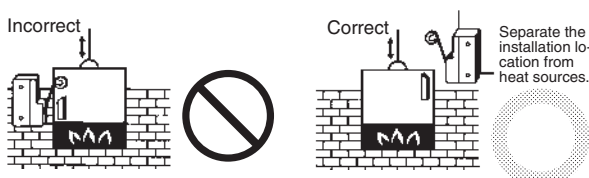

- Mount a cover if the switch is to be installed in a location where worker inattention could result in incorrect operation or accidents.



- Subjecting the switch to continuous vibration or shock may result in contact failure or faulty operation due to abrasion powder and in reduced durability. Excessive vibration or shock will cause the contacts to operate malfunction or become damaged. Mount the switch in a location that is not subject to vibration or shock and in a direction that does not subject the switch to resonance.
- If silver contacts are used with relatively low frequency for a long time or are used with microloads, the sulfide coating produced on the contact surface will not be broken down and contact faults will result. Use a microload switch that uses gold contacts.
- Do not use the switch in atmospheres with high humidity or heat or in harmful gases, such as sulfide gas (H₂S), SO₂, ammonia gas (NH₃), nitric acid gas (HNO₃), or chlorine gas (Cl₂). Doing so may impair functionality, such as with damage due to contacting faults or corrosion.
- The switch includes contacts. If the switch is used in an atmosphere with silicon gas, arc energy may cause silicon oxide (SiO₂) to accumulate on the contacts and result in contact failure. If there is silicon oil, silicon filling, silicon wiring, or other silicon products in the vicinity of the switch, use a contact protection circuit to limit arcing and remove the source of the silicon gas.

Handling

- Set the common (COM) terminal to the positive terminal. If it is set to the negative terminal, the Switch will not turn OFF.
- When using the Switch under an inductive load, the arc suppression capability varies depending on current. If the current becomes 0.6 to 1.2 A or of the time constant L/R exceeds 7 ms, be sure to provide an arc suppressor.
- Since the Switch incorporates a permanent magnet, attention must be paid to the following points:
 - Avoid mounting the Switch directly onto a magnetic substance.
 - Do not subject the Switch to severe shocks.
 - Avoid placing the Switch in a strong magnetic field.
 - Be sure to prevent iron dust or iron chips from adhering to the built-in magnet or the magnetic blowout function of the Switch will be adversely affected.
 - Do not apply thermal shock to the Switch, or the magnetic flux will be diminished.
- Since a ventilation hole is provided to avoid abnormal corrosion due to operating conditions, provide a dustproofing device in locations where the Switch is exposed to dust.
- Do not change operating positions for the actuator. Changing the position may cause malfunction.

Wiring

- Use wire sizes that are suitable to the applied voltage and carried current.
- If you use a soldering iron to solder the wires, do not allow the tip of the soldering iron to exceed 380°C. If a Switch is used with insufficient soldering, abnormal heat and burning may occur.
- Solder for no more than 5 s at 350°C and for no more than 3 s at 380°C. If heat is applied for too long, the case may melt, the lead wire coverings may be scorched, and other characteristics of the Switch may deteriorate.

Panel-mounted Model (X-10G□)

- To side-mount the panel-mount Switch to the panel with screws, remove the hexagonal nut from the actuator.
- Too large a dog angle and too fast operating speed may damage the Switch when the Switch is side-mounted on the panel.
- Too fast operating speed and too long overtravel of the roller plunger Switch may result in damage to the Switch.

Terms and Conditions Agreement

Read and understand this catalog.

Please read and understand this catalog before purchasing the products. Please consult your OMRON representative if you have any questions or comments.

Warranties.

(a) Exclusive Warranty. Omron's exclusive warranty is that the Products will be free from defects in materials and workmanship for a period of twelve months from the date of sale by Omron (or such other period expressed in writing by Omron). Omron disclaims all other warranties, express or implied.

(b) Limitations. OMRON MAKES NO WARRANTY OR REPRESENTATION, EXPRESS OR IMPLIED, ABOUT NON-INFRINGEMENT, MERCHANTABILITY OR FITNESS FOR A PARTICULAR PURPOSE OF THE PRODUCTS. BUYER ACKNOWLEDGES THAT IT ALONE HAS DETERMINED THAT THE PRODUCTS WILL SUITABLY MEET THE REQUIREMENTS OF THEIR INTENDED USE.

Omron further disclaims all warranties and responsibility of any type for claims or expenses based on infringement by the Products or otherwise of any intellectual property right. (c) Buyer Remedy. Omron's sole obligation hereunder shall be, at Omron's election, to (i) replace (in the form originally shipped with Buyer responsible for labor charges for removal or replacement thereof) the non-complying Product, (ii) repair the non-complying Product, or (iii) repay or credit Buyer an amount equal to the purchase price of the non-complying Product; provided that in no event shall Omron be responsible for warranty, repair, indemnity or any other claims or expenses regarding the Products unless Omron's analysis confirms that the Products were properly handled, stored, installed and maintained and not subject to contamination, abuse, misuse or inappropriate modification. Return of any Products by Buyer must be approved in writing by Omron before shipment. Omron Companies shall not be liable for the suitability or unsuitability or the results from the use of Products in combination with any electrical or electronic components, circuits, system assemblies or any other materials or substances or environments. Any advice, recommendations or information given orally or in writing, are not to be construed as an amendment or addition to the above warranty.

See <http://www.omron.com/global/> or contact your Omron representative for published information.

Limitation on Liability; Etc.

OMRON COMPANIES SHALL NOT BE LIABLE FOR SPECIAL, INDIRECT, INCIDENTAL, OR CONSEQUENTIAL DAMAGES, LOSS OF PROFITS OR PRODUCTION OR COMMERCIAL LOSS IN ANY WAY CONNECTED WITH THE PRODUCTS, WHETHER SUCH CLAIM IS BASED IN CONTRACT, WARRANTY, NEGLIGENCE OR STRICT LIABILITY.

Further, in no event shall liability of Omron Companies exceed the individual price of the Product on which liability is asserted.

Suitability of Use.

Omron Companies shall not be responsible for conformity with any standards, codes or regulations which apply to the combination of the Product in the Buyer's application or use of the Product. At Buyer's request, Omron will provide applicable third party certification documents identifying ratings and limitations of use which apply to the Product. This information by itself is not sufficient for a complete determination of the suitability of the Product in combination with the end product, machine, system, or other application or use. Buyer shall be solely responsible for determining appropriateness of the particular Product with respect to Buyer's application, product or system. Buyer shall take application responsibility in all cases.

NEVER USE THE PRODUCT FOR AN APPLICATION INVOLVING SERIOUS RISK TO LIFE OR PROPERTY OR IN LARGE QUANTITIES WITHOUT ENSURING THAT THE SYSTEM AS A WHOLE HAS BEEN DESIGNED TO ADDRESS THE RISKS, AND THAT THE OMRON PRODUCT(S) IS PROPERLY RATED AND INSTALLED FOR THE INTENDED USE WITHIN THE OVERALL EQUIPMENT OR SYSTEM.

Programmable Products.

Omron Companies shall not be responsible for the user's programming of a programmable Product, or any consequence thereof.

Performance Data.

Data presented in Omron Company websites, catalogs and other materials is provided as a guide for the user in determining suitability and does not constitute a warranty. It may represent the result of Omron's test conditions, and the user must correlate it to actual application requirements. Actual performance is subject to the Omron's Warranty and Limitations of Liability.

Change in Specifications.

Product specifications and accessories may be changed at any time based on improvements and other reasons. It is our practice to change part numbers when published ratings or features are changed, or when significant construction changes are made. However, some specifications of the Product may be changed without any notice. When in doubt, special part numbers may be assigned to fix or establish key specifications for your application. Please consult with your Omron's representative at any time to confirm actual specifications of purchased Product.

Errors and Omissions.

Information presented by Omron Companies has been checked and is believed to be accurate; however, no responsibility is assumed for clerical, typographical or proofreading errors or omissions.

2016.3

In the interest of product improvement, specifications are subject to change without notice.

OMRON Corporation
Industrial Automation Company

<http://www.ia.omron.com/>

(c)Copyright OMRON Corporation 2016 All Right Reserved.