

I/O Terminal Socket G70A

16-point I/O Terminal Socket accepts Various Devices such as G2R Relays, Solid State Relays, and Timers for More System Flexibility.

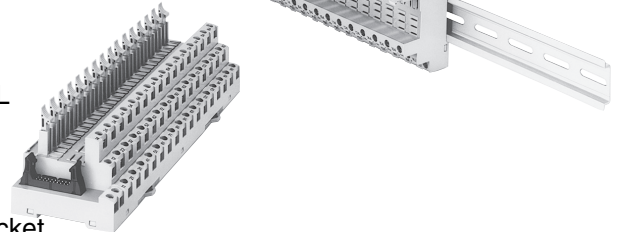

- Connects to a PLC with a simple snap-in connector.
- The G70A-ZOC16-3 can be combined with a DRT1-OD32ML I/O Terminal for DeviceNet connectivity or an SRT2-VOD16ML Connector Terminal for CompoBus/S connectivity.
- SPDT relays can be mounted.
- Conforms to VDE (VDE0106) and CE standards.
- Electric-shock preventive (finger-touch protection) terminal socket.
- DIN rail mountable.
- High-capacity (10 A) terminal socket.
- Excellent noise resistance characteristics.
- Built-in diodes for coil surge suppression.



For the most recent information on models that have been certified for safety standards, refer to your OMRON website.

Ordering Information

I/O Terminal Socket

Classification	Internal I/O common	Rated voltage	Model
Output	NPN (+ common)	24 VDC	G70A-ZOC16-3
	PNP (- common)	24 VDC	G70A-ZOC16-4
Input	NPN/PNP	110 VDC max., 240 VAC max. *	G70A-ZIM16-5

* Each relay to be mounted must incorporate a coil that has proper specifications within the maximum rated voltage range.

Suitable Relay/Solid State Relay/Solid-State Timer

Classification	I/O Terminal Socket	Relay	Solid State Relay (SSR)	Solid-State Timer
Output	NPN: G70A-ZOC16-3 PNP: G70A-ZOC16-4	G2R-1-S G2R-1-SN G2R-1-S (S) G2R-1-SN (S)	G3R-OA202SZN G3R-OA202SLN G3R-ODX02SN G3R-OD201SN G3RZ-201SLN	H3RN-1 H3RN-11
Input	G70A-ZIM16-5	G2R-1A3-SN *1, *2 G2R-13-SN *1, *2 G2R-1A3-SND *1, *2 G2R-13-SND *1, *2	G3R-IAZR1SN G3R-IDZR1SN G3R-IDZR1SN-1	---

*1. G2R-13-SN has twin cross-bar contacts.

*2. Manufacturing of the G2R-1A3-S□ and G2R-13-S□ was discontinued at the end of March 2014.

Accessories (Order Separately) Short Bar

Applicable model	Model
G70A-ZOC16-3 G70A-ZOC16-4 G70A-ZIM16-5	G78-16-E

Connecting Sockets for I/O Terminal Expansion

Number of poles	Model
1 pole (G2R: 1 pole usage)	P2RF-05-E
2 poles (G2R: 2 poles usage)	P2RF-08-E

Cables for I/O Relay Terminals XW2Z-R

- Cable with Loose Wire and Crimp Terminals: XW2Z-RY□C
- Cable with Loose Wires: XW2Z-RA□C
- Cable with connectors
 - Fujitsu connectors (1:1): XW2Z-R□C
 - (1:2): XW2Z-R□C-□
 - (1:3): XW2Z-R□C-□-□
 - (1:1): XW2Z-R□C
 - (1:2): XW2Z-RO□C
 - (1:3): XW2Z-R□-□-□-□
 - (1:1): XW2Z-R□C
 - (1:2): XW2Z-RO□C
 - (1:3): XW2Z-R□-□-□-□
 - XW2Z-RM□-□-□-□
 - XW2Z-RO□-□-□-□

Refer to the **XW2Z-R** Datasheet (Cat. No. G126) for details.

Accessories for DIN Track Mounting

Refer to your OMRON website for details on the PFP-□.

G70A

Specifications

Ratings/Characteristics

Item	G70A-ZOC16-3	G70A-ZOC16-4	G70A-ZIM16-5
Contact resistance	10 mΩ (excluding the resistance of the relay to be used)		
Permissible current	10 A		100 mA
Max. operating voltage	380 VAC, 125 VDC		30 VDC
Dielectric strength	4,000 VAC, 50/60 Hz for 1 min between connector and output terminals 2,000 VAC, 50/60 Hz for 1 min between output terminals 250 VAC, 50/60 Hz for 1 min between connectors		4,000 VAC, 50/60 Hz for 1 min between connector and input terminals 2,000 VAC, 50/60 Hz for 1 min between coil terminals 250 VAC, 50/60 Hz for 1 min between connectors
Insulation resistance	Between connector and I/O terminals: 1,000 MΩ (at 500 V) Other: 100 MΩ (at 500 V)		
Vibration resistance	Malfunction: 10 to 61.2 to 10 Hz, 0.1-mm single amplitude (0.2-mm double amplitude); 61.2 to 150 to 61.2 Hz, 14.7 m/s ²		
Shock resistance	Malfunction: 200 m/s ²		
Noise immunity	Noise level: 2.0 kV; pulse width: 100 ns to 1 μs		
Ambient temperature	Operating: 0 to 55°C (with no condensation or icing)		
Ambient humidity	Operating: 35% to 85%		
Coil surge absorption element	Diode: 1 A, 400 V		Varistor *
Protection diode for inverse connection	Diode (2 A, withstand inverse voltage: 40 V)		
Tensile strength	No damage when a tensile force of 49 N is applied for 1 second in any direction		
I/O terminal tightening torque	Tightening strength: 0.59 N·m; Tensile strength 49 N for 1 min.		
Weight	Approx. 400 g		

* Use a DC relay with a built-in diode because a DC relay without a built-in diode does not absorb any coil surge.

Approved standards G70A

UL508	Fille No. E95399
CSA C22.2 (No.14)	Fille No. LR 35535
VDE EN-50178	Fille No. 125362

●Relay (G2R-1-S, G2R-1-SN, G2R-1-S (S), G2R-1-SN (S))

Coil Ratings

Rated voltage	24 VDC	
Rated current	21.8 mA	
Coil resistance	1,100 Ω	
Coil inductance	Armature OFF	4.27
(H) (ref. value)	Armature ON	8.55
Must operate voltage	70% min. of rated voltage	
Must release voltage	15% min. of rated voltage	
Max. voltage	110% of rated voltage	
Power consumption	Approx. 0.53 W	

Contact Ratings

Number of poles	1 pole	
Load	Resistive load (cosφ = 1)	Inductive load (cosφ = 0.4; L/R = 7 ms)
Rated load	10 A at 250 VAC; 10 A at 30 VDC	7.5 A at 250 VAC; 5 A at 30 VDC
Rated carry current	10 A	
Max. operating voltage	380 VAC, 125 VDC	
Max. operating current	10 A	
Max. switching capacity	2,500 VA, 300 W	1,875 VA, 150 W
Min. permissible load	100 mA at 5 VDC	

●Relay (G2R-1A3-SN (SND), G2R-13-SN (SND))

Coil Ratings

Rated voltage		230 VAC	12 VDC	24 VDC
Rated current	50 Hz	3.7 mA	43.6 mA	21.8 mA
	60 Hz	3.1 mA		
Coil resistance		30,000 Ω	275 Ω	1,100 Ω
Must operate voltage		80% max. of rated voltage	70% max. of rated voltage	
Must release voltage		30% min. of rated voltage	15% min. of rated voltage	
Max. voltage		110% of rated voltage		
Power consumption		Approx. 0.7 W (60 Hz)	Approx. 0.53 W	

Note: 1. The rated current and coil resistance are measured at a coil temperature of 23°C with a tolerance of $+15\%/_{-20\%}$ (AC rated current) or $\pm 10\%$ (DC coil resistance).

2. LEDs are used for the built-in operation indicator. For models equipped with these indications, the VAC rated current must be increased by approximately 1 mA; the VDC rated current, by approximately 4 mA.

3. Operating characteristics are measured at a coil temperature of 23°C.

Contact Ratings

Refer to Ratings/Characteristics of G70A-ZIM16-5.

●Solid State Relay (G3R-I/O)

Ratings

Input Module

Input

Model	Rated voltage	Operating voltage	Input current	Must operate voltage	Must release voltage
G3R-IAZR1SN	100 to 240 VAC	60 to 264 VAC	15 mA max.	60 VAC max.	20 VAC min.
G3R-IDZR1SN	5 VDC	4 to 6 VDC	8 mA max.	4 VDC max.	1 VDC min.
	12 to 24 VDC	6.6 to 32 VDC		6.6 VDC max.	3.6 VDC min.
G3R-IDZR1SN-1	5 VDC	4 to 6 VDC		4 VDC max.	1 VDC min.
	12 to 24 VDC	6.6 to 32 VDC		6.6 VDC max.	3.6 VDC min.

Output

Model	Load voltage	Load current
G3R-IAZR1SN	4 to 32 VDC	0.1 to 100 mA
G3R-IDZR1SN		
G3R-IDZR1SN-1		

Output Module

Input

Model	Rated voltage	Operating voltage	Input current	Must operate voltage	Must release voltage
G3R-OA202SZN	5 to 24 VDC	4 to 32 VDC	15 mA max. (at 25°C)	4 VDC max.	1 VDC min.
G3R-OA202SLN			8 mA max.		
G3R-ODX02SN					
G3R-OD201SN					

Output

Model	Load voltage	Load current *1, *2	Inrush current
G3R-OA202SZN	75 to 264 VAC	0.05 to 2 A	30 A (60 Hz, 1 cycle)
G3R-OA202SLN			
G3R-ODX02SN	4 to 60 VDC	0.01 to 2 A	8 A (10 ms)
G3R-OD201SN	40 to 200 VDC	0.01 to 1.5 A	8 A (10 ms)

*1. Depends on the ambient temperature. Refer to the Engineering Data (Reference Value) *Load Current vs. Ambient Temperature Rating* on page 6 for details.

*2. The minimum current value is measured at 10°C min.

Characteristics

Input Module

Item	G3R-IAZR1SN	G3R-IDZR1SN	G3R-IDZR1SN-1
Operate time	20 ms max.	0.1 ms max.	15 ms max.
Release time	20 ms max.	0.1 ms max.	15 ms max.
Response frequency	10 Hz	1 kHz	10 Hz
Output ON voltage drop	1.6 V max.		
Leakage current	5 μ A max.		
Insulation resistance	100 M Ω min. between input and output		
Dielectric strength	4,000 VAC, 50/60 Hz for 1 min between input and output		
Vibration resistance	10 to 55 to 10 Hz, 0.75-mm single amplitude (1.5-mm double amplitude)		
Shock resistance	1,000 m/s ²		
Ambient temperature	Operating: -30 to 80°C (with no icing) Storage: -30 to 100°C (with no icing)		
Ambient humidity	Operating: 45% to 85%		
Weight	Approx. 18 g		

Output Module

Item	G3R-OA202SZN	G3R-OA202SLN	G3R-ODX02SN	G3R-OD201SN
Operate time	1/2 of load power source cycle + 1 ms max.	1 ms max.		
Release time	1/2 of load power source cycle + 1 ms max.		2 ms max.	
Response frequency	20 Hz		100 Hz	
Output ON voltage drop	1.6 V max.			2.5 V max.
Leakage current	1.5 mA max.		1 mA max.	
Insulation resistance	100 M Ω min. between input and output			
Dielectric strength	4,000 VAC, 50/60 Hz for 1 min between input and output			
Vibration resistance	10 to 55 to 10 Hz, 0.75-mm single amplitude (1.5-mm double amplitude)			
Shock resistance	1,000 m/s ²			
Ambient temperature	Operating: -30 to 80°C (with no icing) Storage: -30 to 100°C (with no icing)			
Ambient humidity	Operating: 45% to 85%			
Weight	Approx. 18 g			

●Solid State Relay (G3RZ)

Ratings

Item Model	Input					Output			
	Rated voltage	Operating voltage	Impedance	Voltage level		Rated load voltage	Load voltage range	Load current *	Surge withstand current
				Must-operate voltage	Must-release voltage				
G3RZ-201SLN	5 VDC	4 to 6 VDC	400 Ω \pm 20%	4 VDC max.	1 VDC min.	5 to 240 VAC 5 to 100 VDC	3 to 264 VAC 3 to 125 VDC	100 μ A to 1.0 A	10 A (10 ms)
	12 VDC	9.6 to 14.4 VDC	1.1 k Ω \pm 20%	9.6 VDC max.					
	24 VDC	19.2 to 28.8 VDC	2.2 k Ω \pm 20%	19.2 VDC max.					

* Depends on the ambient temperature. Refer to the reference data *Load Current vs. Ambient Temperature Rating* on page 6 for details.

Characteristics

Operation time	6 ms max.
Release time	10 ms max.
Output ON resistance	2.4 Ω max.
OFF leakage current	10 μ A max. (at 125 VDC) 100 μ A max. (at 200 VAC)
Insulation resistance	100 M Ω min. (at 500 VDC)
Dielectric strength	2,500 VAC at 50/60 Hz for 1 min. between inputs and outputs
Vibration resistance	10 to 55 to 10 Hz, 0.75-mm single amplitude (1.5-mm double amplitude)
Shock resistance	1,000 m/s ²
Storage temperature	-30 to 100°C (with no icing or condensation)
Ambient operating temperature	-30 to 85°C (with no icing or condensation)
Ambient operating humidity	45% to 85%
Weight	Approx. 20 g

●Solid-State Timer (H3RN)

For H3RN specifications, refer to the H3RN Datasheet.

G70A

Engineering Data (Reference Value)

When Mounted to a G2R

Endurance

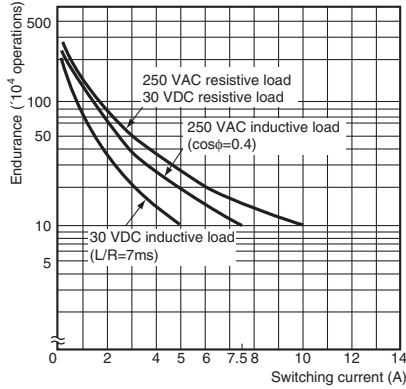

Maximum Switching Power G2R-1-S (24 VDC)

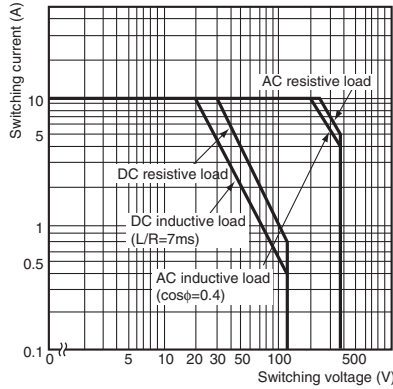

Note: The characteristics shown here are for 16-point mounting. This data was produced from actual values sampled on production lines, and should be used for reference purposes only. Since relays are mass-produced, a certain amount of tolerance is generally allowed in their application.

When Mounted to a G3R-I/O

Load Current vs. Ambient Temperature Rating

G3R-OA202SZN
G3R-OA202SLN

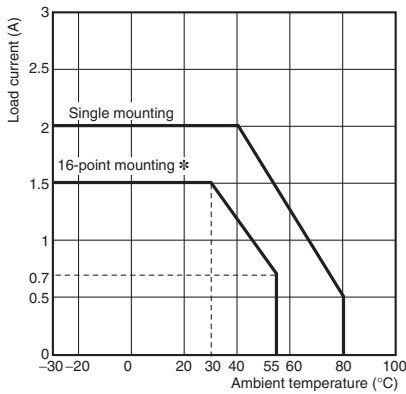

G3R-ODX02SN

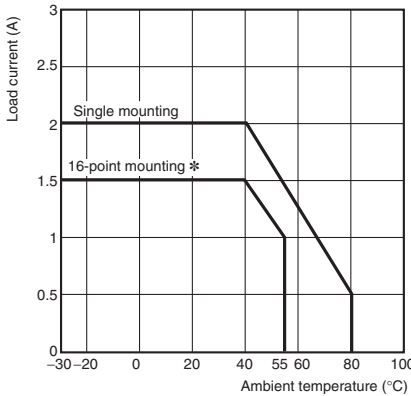

G3R-OD201SN

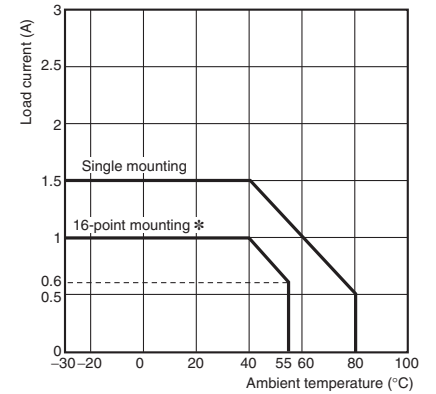

* On G70A-ZOC16, fully mounted.

Inrush Current Resistivity

Non-repetitive (Keep the inrush current to half the rated value if it occurs repetitively.)

G3R-OA202SZN
G3R-OA202SLN

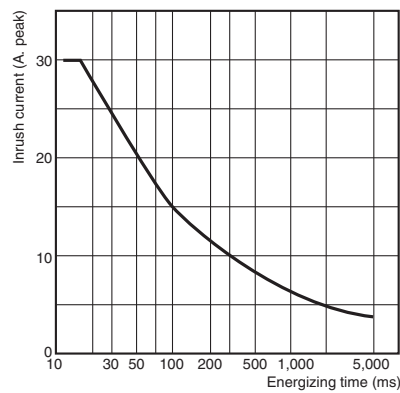

G3R-ODX02SN

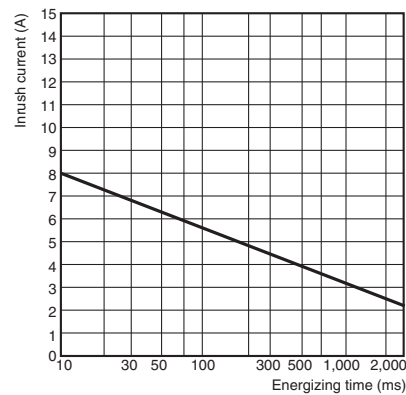

G3R-OD201SN

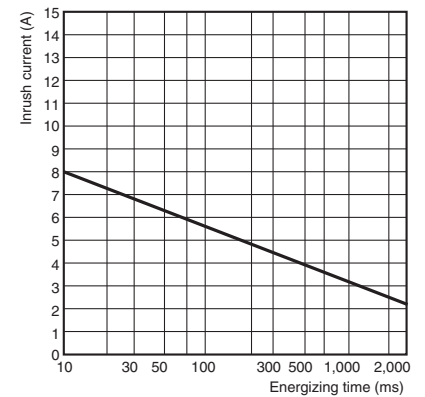

When Mounted to a G3RZ

Load Current vs. Ambient Temperature Rating

G3RZ-201SLN

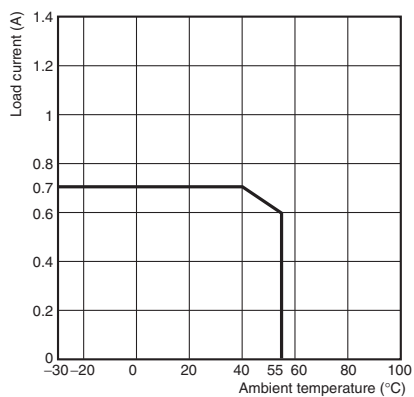

Inrush Current Resistivity

Non-repetitive (Keep the inrush current to half the rated value if it occurs repetitively.)

G3RZ-201SLN

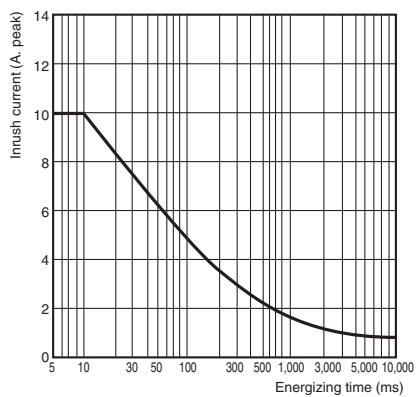

G70A

Internal Circuits

• G70A-ZOC16-3 (NPN)

NPN (positive common): The output at the connected controller will have a negative common from an NPN transistor.

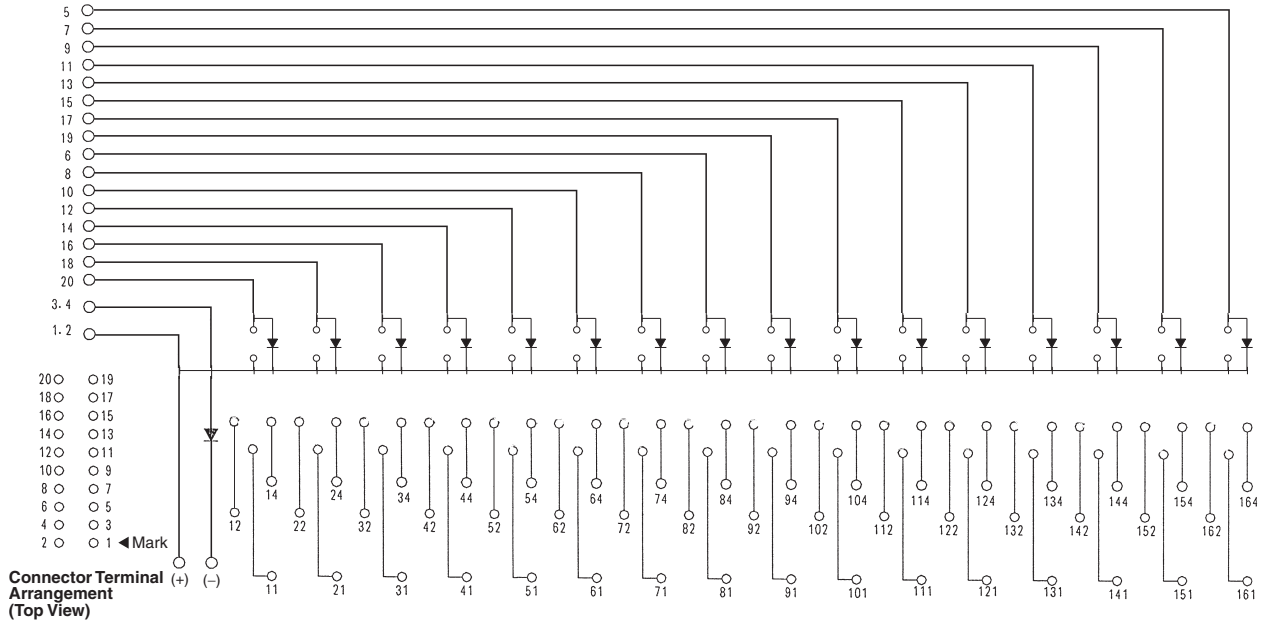

G70A-ZOC16-4 (PNP)

PNP (negative common): The output at the connected controller will have a positive common from a PNP transistor.

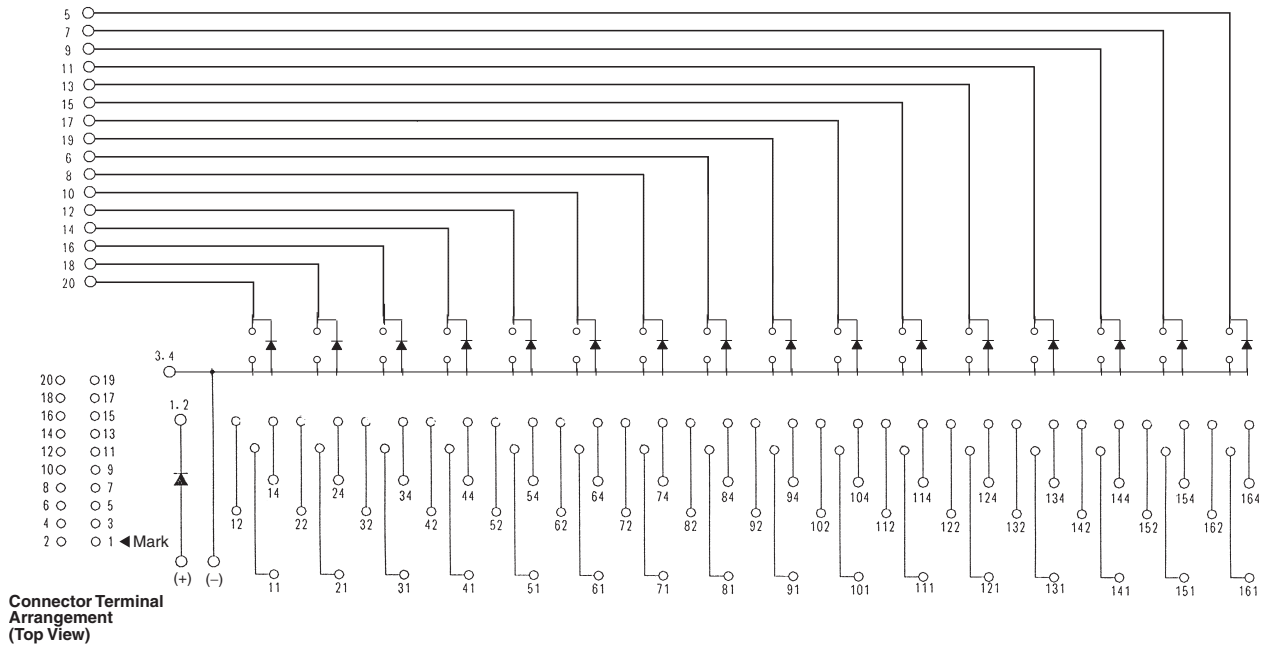

Note: Pin numbers are indicated for convenience. The ▲ mark can be used to determine orientation.

G70A-ZIM16-5 (NPN/PNP)

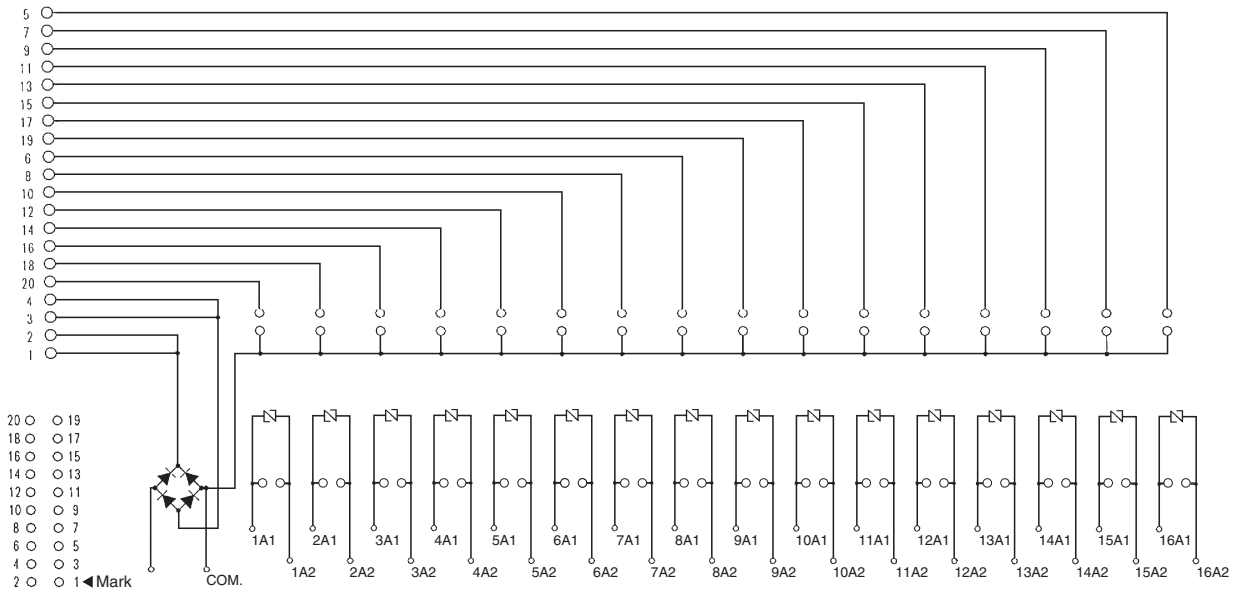

Connector Terminal Arrangement (Top View)

Note: Pin numbers are indicated for convenience. The ▲ mark can be used to determine orientation.

G70A

Dimensions

(Unit: mm)

G70A-ZOC16 (Output)

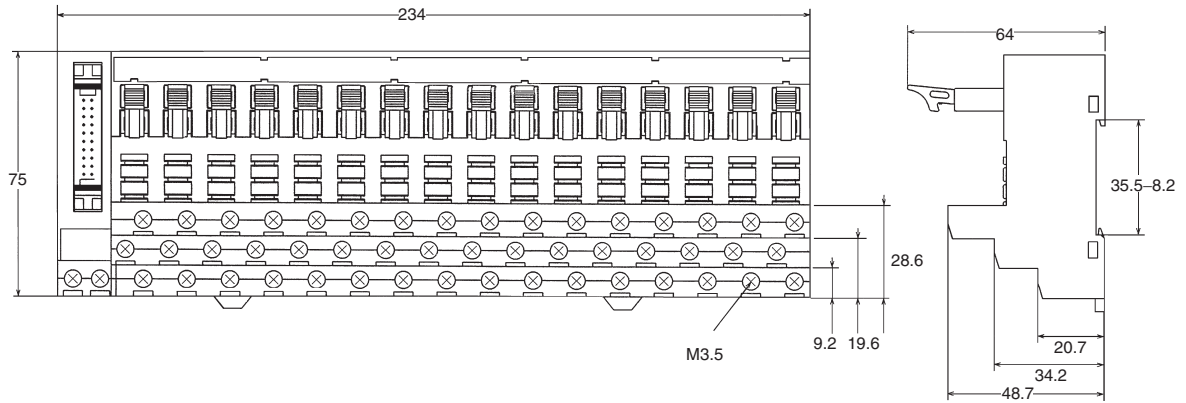

G70A-ZIM16 (Input)

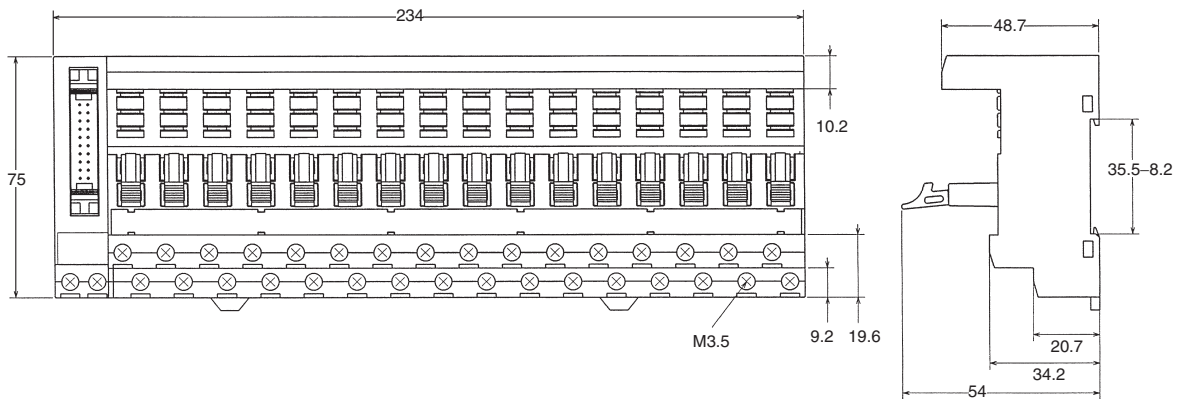

Terminal Arrangement/Internal Connection

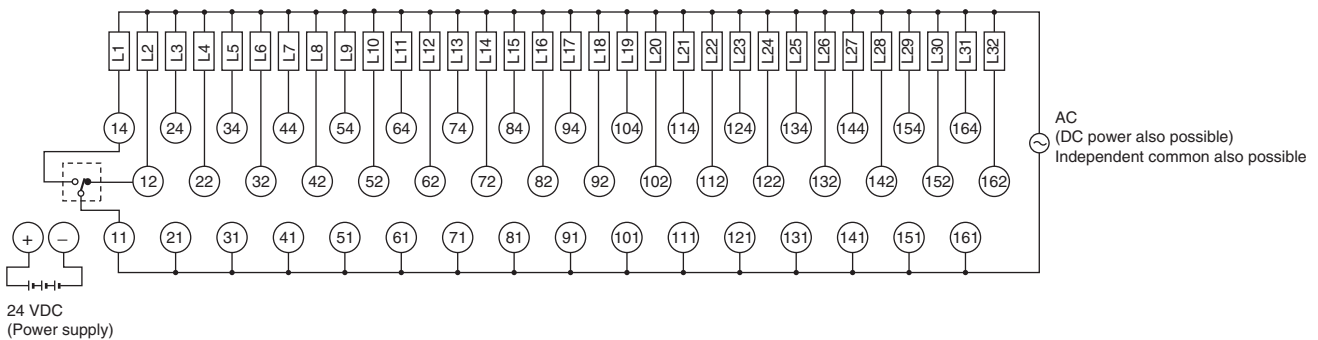

Note: The above diagram shows the Unit mounted to a G2R-1-S.
 When mounting to a G3R-OA□ or G3RZ-201SLN, pins 11 to 14 are output terminals.
 When mounting to a G3R-OD□, pin 14 is a plus terminal and pin 11 is a minus terminal. When mounting to G3RZ-201SLN, there is no polarity.

Safety Precautions

Be sure to read *the Safety Precautions for All I/O Relay Terminals* in the website: <http://www.ia.omron.com/>.

Terms and Conditions Agreement

Read and understand this catalog.

Please read and understand this catalog before purchasing the products. Please consult your OMRON representative if you have any questions or comments.

Warranties.

- (a) Exclusive Warranty. Omron's exclusive warranty is that the Products will be free from defects in materials and workmanship for a period of twelve months from the date of sale by Omron (or such other period expressed in writing by Omron). Omron disclaims all other warranties, express or implied.
- (b) Limitations. OMRON MAKES NO WARRANTY OR REPRESENTATION, EXPRESS OR IMPLIED, ABOUT NON-INFRINGEMENT, MERCHANTABILITY OR FITNESS FOR A PARTICULAR PURPOSE OF THE PRODUCTS. BUYER ACKNOWLEDGES THAT IT ALONE HAS DETERMINED THAT THE PRODUCTS WILL SUITABLY MEET THE REQUIREMENTS OF THEIR INTENDED USE.

Omron further disclaims all warranties and responsibility of any type for claims or expenses based on infringement by the Products or otherwise of any intellectual property right. (c) Buyer Remedy. Omron's sole obligation hereunder shall be, at Omron's election, to (i) replace (in the form originally shipped with Buyer responsible for labor charges for removal or replacement thereof) the non-complying Product, (ii) repair the non-complying Product, or (iii) repay or credit Buyer an amount equal to the purchase price of the non-complying Product; provided that in no event shall Omron be responsible for warranty, repair, indemnity or any other claims or expenses regarding the Products unless Omron's analysis confirms that the Products were properly handled, stored, installed and maintained and not subject to contamination, abuse, misuse or inappropriate modification. Return of any Products by Buyer must be approved in writing by Omron before shipment. Omron Companies shall not be liable for the suitability or unsuitability or the results from the use of Products in combination with any electrical or electronic components, circuits, system assemblies or any other materials or substances or environments. Any advice, recommendations or information given orally or in writing, are not to be construed as an amendment or addition to the above warranty.

See <http://www.omron.com/global/> or contact your Omron representative for published information.

Limitation on Liability; Etc.

OMRON COMPANIES SHALL NOT BE LIABLE FOR SPECIAL, INDIRECT, INCIDENTAL, OR CONSEQUENTIAL DAMAGES, LOSS OF PROFITS OR PRODUCTION OR COMMERCIAL LOSS IN ANY WAY CONNECTED WITH THE PRODUCTS, WHETHER SUCH CLAIM IS BASED IN CONTRACT, WARRANTY, NEGLIGENCE OR STRICT LIABILITY.

Further, in no event shall liability of Omron Companies exceed the individual price of the Product on which liability is asserted.

Suitability of Use.

Omron Companies shall not be responsible for conformity with any standards, codes or regulations which apply to the combination of the Product in the Buyer's application or use of the Product. At Buyer's request, Omron will provide applicable third party certification documents identifying ratings and limitations of use which apply to the Product. This information by itself is not sufficient for a complete determination of the suitability of the Product in combination with the end product, machine, system, or other application or use. Buyer shall be solely responsible for determining appropriateness of the particular Product with respect to Buyer's application, product or system. Buyer shall take application responsibility in all cases.

NEVER USE THE PRODUCT FOR AN APPLICATION INVOLVING SERIOUS RISK TO LIFE OR PROPERTY OR IN LARGE QUANTITIES WITHOUT ENSURING THAT THE SYSTEM AS A WHOLE HAS BEEN DESIGNED TO ADDRESS THE RISKS, AND THAT THE OMRON PRODUCT(S) IS PROPERLY RATED AND INSTALLED FOR THE INTENDED USE WITHIN THE OVERALL EQUIPMENT OR SYSTEM.

Programmable Products.

Omron Companies shall not be responsible for the user's programming of a programmable Product, or any consequence thereof.

Performance Data.

Data presented in Omron Company websites, catalogs and other materials is provided as a guide for the user in determining suitability and does not constitute a warranty. It may represent the result of Omron's test conditions, and the user must correlate it to actual application requirements. Actual performance is subject to the Omron's Warranty and Limitations of Liability.

Change in Specifications.

Product specifications and accessories may be changed at any time based on improvements and other reasons. It is our practice to change part numbers when published ratings or features are changed, or when significant construction changes are made. However, some specifications of the Product may be changed without any notice. When in doubt, special part numbers may be assigned to fix or establish key specifications for your application. Please consult with your Omron's representative at any time to confirm actual specifications of purchased Product.

Errors and Omissions.

Information presented by Omron Companies has been checked and is believed to be accurate; however, no responsibility is assumed for clerical, typographical or proofreading errors or omissions.

OMRON Corporation Industrial Automation Company
Kyoto, JAPAN

Contact: www.ia.omron.com

Regional Headquarters

OMRON EUROPE B.V.

Wegalaan 67-69, 2132 JD Hoofddorp
The Netherlands

Tel: (31)2356-81-300/Fax: (31)2356-81-388

OMRON ELECTRONICS LLC

2895 Greenspoint Parkway, Suite 200
Hoffman Estates, IL 60169 U.S.A.

Tel: (1) 847-843-7900/Fax: (1) 847-843-7787

OMRON ASIA PACIFIC PTE. LTD.

No. 438A Alexandra Road # 05-05/08 (Lobby 2),
Alexandra Technopark,
Singapore 119967

Tel: (65) 6835-3011/Fax: (65) 6835-2711

OMRON (CHINA) CO., LTD.

Room 2211, Bank of China Tower,
200 Yin Cheng Zhong Road,
PuDong New Area, Shanghai, 200120, China
Tel: (86) 21-5037-2222/Fax: (86) 21-5037-2200

Authorized Distributor:

© OMRON Corporation 2002-2017 All Rights Reserved.
In the interest of product improvement,
specifications are subject to change without notice.

CSM_1_1_0117
Cat. No. **J087-E1-04**

0117(1092)