

NEW

OMRON

N-Smart

Presence / Detection / Measurement

Smart Fiber Amplifier Units
E3NX-FA

Industry-leading Levels* of Performance
Highly Stable Detection

Easy Setup for Any Workpiece by Any Operator



realizing

EtherCAT®
CompoNet™
CC-Link V2

* For performance (sensing distance and minimum sensing object) based on November 2013 OMRON investigation.

The No. 1 Performance Worldwide^{*1} for Even More Applications

Best Performance in the World^{*1}

1.5 Times the Sensing Distance^{*2}

6 m

For E32-LT11 Fiber Unit with a fiber length of 3.5 m

1/10th the Minimum Sensing Object^{*2}

0.3 μm dia.

Typical example of actual measurements
with E32-D11R Fiber Unit

Three Technologies That Support High Performance

Optical Coupling Efficiency of 40%

The lens and reflector eliminate lost light to emit powerful, uniform emission.

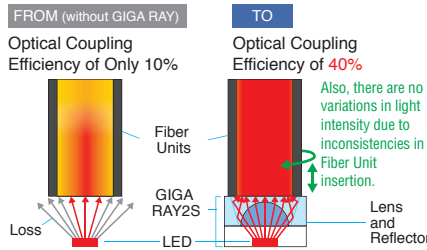

High Power to Achieve Stable Detection

HIGH-EFFICIENCY
COUPLING ELEMENT
GIGA RAY2S

PAT.P



Low Noise to Accurately Capture Signals

LIGHT RECEPTION
ALGORITHM
**Smart Noise
Reduction**

Signal-to-Noise Ratio Improved 2.5 Times

The influences of noise are reduced to achieve stable incident light levels by increasing the number of samples taken. This increases the margin for threshold values to achieve stable detection.

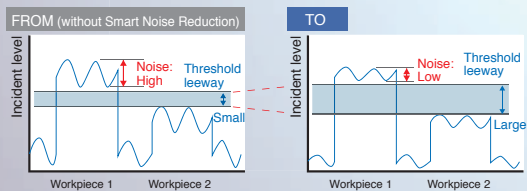

High-speed, High-precision Signal Processing

HIGH-SPEED,
HIGH-PRECISION IC
N-Core

Twice the Processing Speed^{*3}

Point



Response Time of 30 μs in High-speed Mode^{*4}

You can adjust the light intensity to detect fast-moving workpieces more accurately.*2



*1. For performance (sensing distance and minimum sensing object) based on November 2013 OMRON investigation. *2. Compared with E3X-HD. *3. Compared with E3X-HD for normal operation processing. *4. Model with 1 output: 30 μs, model with 2 outputs: 32 μs.

Ultra-easy

Easily Handle a Wide Range of Applications with the Press of a Single Button

Consistent Settings for All Users **Smart Tuning Settings** PAT.P

Conventional Models*1

1st Step

Adjust light intensity.

2nd Step

Set threshold.

*1. Fiber Amplifier Unit without Smart Tuning.

E3NX-FA

Press the **S_{TUNE}** button **once** with a workpiece and **once** without a workpiece

Automatically set the light intensity and threshold to optimum values in **1 Step**.

Threshold	Incident Level
5000	9999

Set to the intermediate value between the incident levels with and without a workpiece.

Incident level adjustment with and without a workpiece.

Automatic Adjustment to Optimum Incident Level

Wide Light Intensity Adjustment Range from Transparent Objects to Black Workpieces

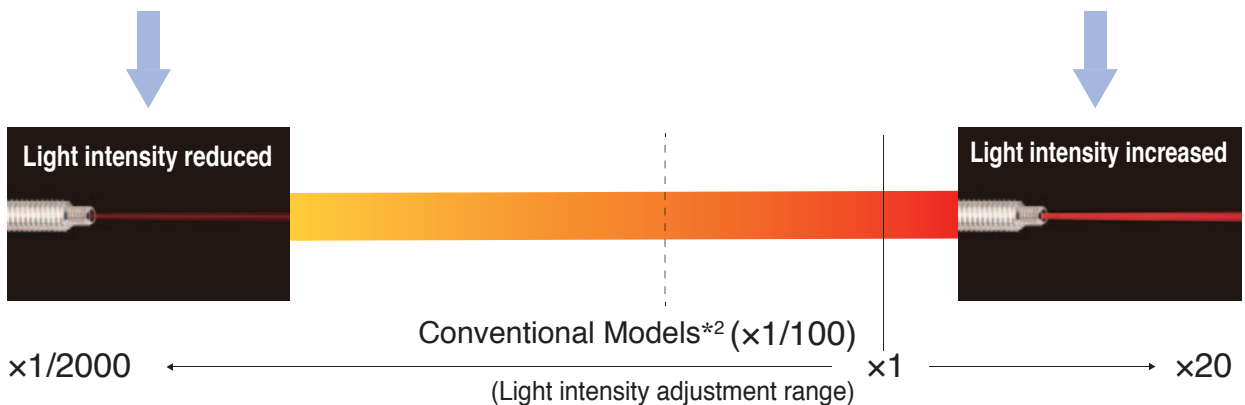
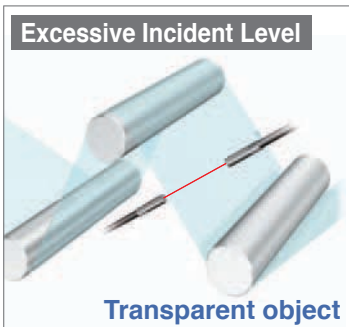

Wider light intensity adjustment range of 40,000 times (Conventional models*2: 2,000 times)
You can automatically adjust the light intensity to an optimum value for stable detection even with saturated or insufficient incident light.

*2. E3X-HD

Ultra-reliable

Two Decision Support Functions to Help You

Visual Displays of the Passing Time and Difference in Incident Levels.

Solution Viewer **PAT.P**



Passing time Difference in incident level

Selecting Fiber Units

Just about anyone can make a quantitative decision without special skills.

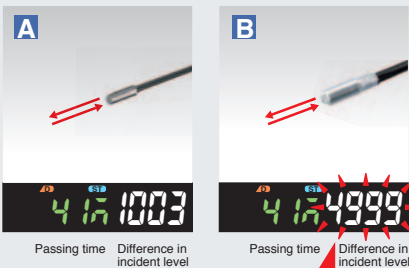

The difference in incident level is large, so use B.

Setting Optimum Thresholds and Modes

You can see the passing time and difference in incident levels to facilitate manual setup.

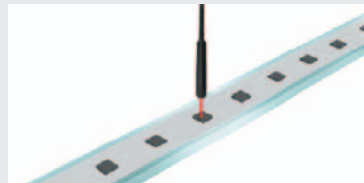

The passing time is "13 ms", so it is OK with Standard Mode.

The incident light level difference is 4,000 when the level is 5,000 with a workpiece, so a threshold of 3,000 is OK.

Visual Information for Fast Workpieces

Change Finder **PAT.P**

You can confirm changes in displayed values for fast workpieces to accurately set the threshold.

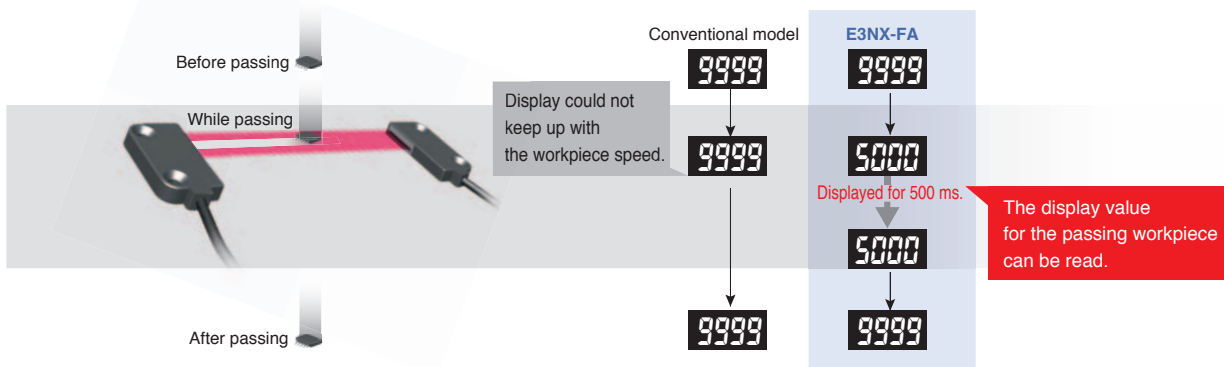

The display value for the passing workpiece can be read.

Point



Advanced DPC (Dynamic Power Control) **PAT.P**

Predictive Maintenance to Reduce Downtime

An alarm output* has been added to the DPC that automatically compensates differences in the incident level. A maintenance signal is output when the incident level drops due to dirt or vibration for use in predictive maintenance. (We recommend DPC for through-beam or retro-reflective models.)

*An alarm output is supported only on models with two outputs.

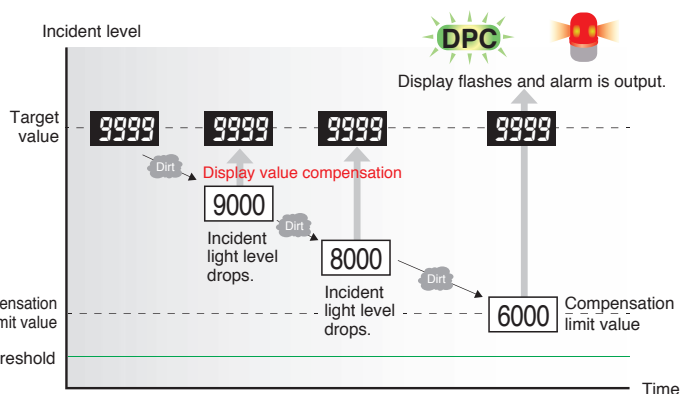

Simpler and More Dependable

The N-Smart Lineup of Next-generation Fiber Sensors and Laser Sensors will quickly solve your problems and therefore increase equipment operation rates and minimize downtime with optimum cost performance.

Stable Detection with the No. 1 Performance

E3NX-FA Fiber Amplifier Units

N-Smart Amplifier Units
Easy application with consistent operating procedures.

E3NX-CA Color Fiber Amplifier Unit
Cat. No. Y216

High Color Discrimination Capability

E3NC Smart Laser Sensors
Cat. No. E427

From Minute Workpieces to Long-distance Detection

E9NC-T Contact-Type Smart Sensor
Cat. No. E433

Handles Advanced Measurement Applications

E3NW Sensor Communications Units
Cat. No. E428

Applications with Many Sensors:
More convenience and even lower costs with a network.

N-Smart
Presence / Detection / Measurement

EtherCAT
CompoNet
CC-Link V2

Common Features and Models in the N-Smart Series

Common Buttons

Intuitive Operation and Easy Setup.



White Characters on a Black background

High-contrast displays for easy visibility from a distance.

Models with Wire-saving Connectors **Popular**

No Master/Slave Distinctions in Amplifier Units

- Reduce model numbers in stock**
You do not need to stock both master and slave amplifier units.
- Greatly reduced wiring work**
Power is supplied from the Master Connector. Slave Connectors have only output lines.
- Expansion is easy and reliable**
Mutual interference prevention works even if you use a Master Connector instead of a Slave Connector or combine them with pre-wired models.

Optical communications (mutual interference prevention)

Slave Connector
Output line only.

Power supplied.

Master Connector
Power line + Output line

Model for Sensor Communications Unit

Data Management and Time Reduction with Network Communications

- Three communications methods are supported
- Use Distributed Sensor Units to reduce equipment production costs and commissioning time







Controller

EtherCAT
CompoNet
CC-Link V2

E3NW Cat.No.E428

Ordering Information

Fiber Amplifier Units

Type	Connecting method	Appearance	Inputs/outputs	Model	
				NPN output	PNP output
Standard models	Pre-wired (2 m)		1 output	E3NX-FA11 2M	E3NX-FA41 2M
	Wire-saving Connector		1 output	E3NX-FA6	E3NX-FA8
Advanced models	Pre-wired (2 m)		2 outputs + 1 input	E3NX-FA21 2M	E3NX-FA51 2M
	Wire-saving Connector		1 output + 1 input	E3NX-FA7	E3NX-FA9
			2 outputs	E3NX-FA7TW	E3NX-FA9TW
	M8 Connector		1 output + 1 input	E3NX-FA24	E3NX-FA54
			2 outputs	—	E3NX-FA54TW
Model for Sensor Communications Unit*	Connector for Sensor Communications Unit		—	E3NX-FA0	

* A Sensor Communications Unit is required to connect Fiber Amplifier Units to a network.

Accessories (Sold Separately)

Wire-saving Connectors

(Required for models for Wiresaving Connectors.)

Connectors are not provided with the Fiber Amplifier Unit and must be ordered separately. *Protective stickers are attached. Cable length is 2 m.

Type	No. of conductors	Model	Applicable Fiber Amplifier Units
Master Connector	4	E3X-CN21	E3NX-FA7 E3NX-FA7TW
Slave Connector	2	E3X-CN22	E3NX-FA9 E3NX-FA9TW
Master Connector	3	E3X-CN11	E3NX-FA6 E3NX-FA8
Slave Connector	1	E3X-CN12	

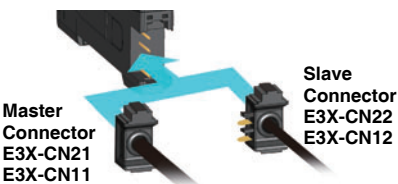

There is no distinction between master and slave on the Amplifier Unit. Purchase the Connector and Amplifier Unit together according to the application.

Sensor I/O Connectors

(Required for models for M8 Connectors.)

Connectors are not provided with the Fiber Amplifier Unit and must be ordered separately.

Size	Appearance	Cable type	Model
M8	Straight	2 m	XS3F-M421-402-A
		5 m	XS3F-M421-405-A
	L-shaped	2 m	XS3F-M422-402-A
		5 m	XS3F-M422-405-A

Mounting Bracket

A Mounting Bracket is not provided with the Fiber Amplifier Unit and must be ordered separately as required.

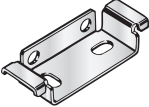
Appearance	Model	Quantity
	E39-L143	1

End Plate

Two End Plates are provided with the Sensor Communications Unit. An End Plate is not provided with the Fiber Amplifier Unit and must be ordered separately as required.

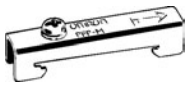
Appearance	Model	Quantity
	PPF-M	1

Cover

Attach these Covers to Amplifier Units. Order a Cover when required, e.g., if you lose the covers.

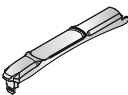
Appearance	Model	Quantity
	E39-G25 FOR E3NX-FA	1

Related Products

Sensor Communications Units

Type	Model
Sensor Communications Unit for EtherCAT	E3NW-ECT
Sensor Communications Unit for CompoNet	E3NW-CRT
Sensor Communications Unit for CC-Link	E3NW-CCL
Distributed Sensor Unit *	E3NW-DS

Refer to your OMRON website for details.

* The Distributed Sensor Unit can be connected to any of the Sensor Communications Units.

Ratings and Specifications

Item	Type	Standard models				Advanced models				Model for Sensor Communications Unit
		NPN output	E3NX-FA11	E3NX-FA6	E3NX-FA21	E3NX-FA7	E3NX-FA7TW	E3NX-FA24	—	E3NX-FA0
		PNP output	E3NX-FA41	E3NX-FA8	E3NX-FA51	E3NX-FA9	E3NX-FA9TW	E3NX-FA54	E3NX-FA54TW	
Connecting method	Pre-wired	Wire-saving Connector	Pre-wired	Wire-saving Connector	M8 Connector			Connector for Sensor Communications Unit		
Inputs/outputs	Outputs	1 output		2 outputs	1 output	2 outputs	1 output	2 outputs	—*3	
	External inputs	—		1 input	1 input	—	1 input	—		
Light source (wavelength)		Red, 4-element LED (625 nm)								
Power supply voltage		10 to 30 VDC, including 10% ripple (p-p)								
Power consumption *1		At Power supply voltage of 24 VDC Standard Models: Normal mode : 840 mW max. (Current consumption at 35 mA max.) Eco function ON : 650 mW max. (Current consumption at 27 mA max.) Advanced Models or Model for Sensor Communications Unit: Normal mode : 920 mW max. (Current consumption at 38 mA max.) Eco function ON : 680 mW max. (Current consumption at 28 mA max.)								
Control outputs		Load power supply voltage: 30 VDC max., open-collector output Load current: Groups of 1 to 3 Amplifier Units: 100 mA max., Groups of 4 to 30 Amplifier Units: 20 mA max. (Residual voltage: At load current of less than 10 mA: 1 V max.) At load current of 10 to 100 mA: 2 V max.) OFF current: 0.1 mA max.							—	
Response time	Super-high-speed mode (SHS) *2	Operate or reset for model with 1 output: 30 μs, with 2 outputs: 32 μs								
	High-speed mode (HS)	Operate or reset: 250 μs								
	Standard mode (Std)	Operate or reset: 1 ms								
	Giga-power mode (GiGA)	Operate or reset: 16 ms								
Maximum connectable Units		30								
No. of Units for mutual interference prevention	Super-high-speed mode (SHS) *2	0								
	High-speed mode (HS)	10								
	Standard mode (Std)	10								
	Giga-power mode (GiGA)	10								
Functions		Auto power control (APC), dynamic power control (DPC), timer, zero reset, resetting settings, eco mode, bank switching, power tuning, and hysteresis width								

* For details, refer to the Fiber Sensor Best Selection Catalog (Cat No. E418).

*1. At Power Supply Voltage of 10 to 30 VDC

Standard Models:

Normal mode : 990 mW max. (Current consumption: 33 mA max. at 30 VDC, 65 mA max. at 10 VDC)

Eco function ON : 780 mW max. (Current consumption: 26 mA max. at 30 VDC, 42 mA max. at 10 VDC)

Advanced Models:

Normal mode : 1,020 mW max. (Current consumption: 34 mA max. at 30 VDC, 67 mA max. at 10 VDC)

Eco function ON : 810 mW max. (Current consumption: 27 mA max. at 30 VDC, 44 mA max. at 10 VDC)

*2. The mutual interference prevention function is disabled if the detection mode is set to super-high-speed mode.

*3. Two sensor outputs are allocated in the programmable logic controller PLC I/O table.

PLC operation via Communications Unit enables reading detected values and changing settings.

Dimensions

(Unit: mm)
Tolerance class IT16 applies to dimensions in this data sheet unless otherwise specified.

Pre-wired Amplifier Units

E3NX-FA11
E3NX-FA21
E3NX-FA41
E3NX-FA51

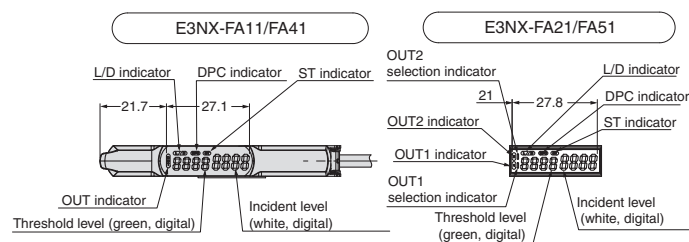

*Cable Specifications

Model	Outer diameter	No. of conductors	Others
E3NX-FA11	4.0 dia.	3	Conductor cross-section: 0.2 mm ² Insulator dia.: 0.9 mm
E3NX-FA41	4.0 dia.	3	
E3NX-FA21	4.0 dia.	5	Standard length: 2 m Minimum bending radius: 12 mm
E3NX-FA51	4.0 dia.	5	

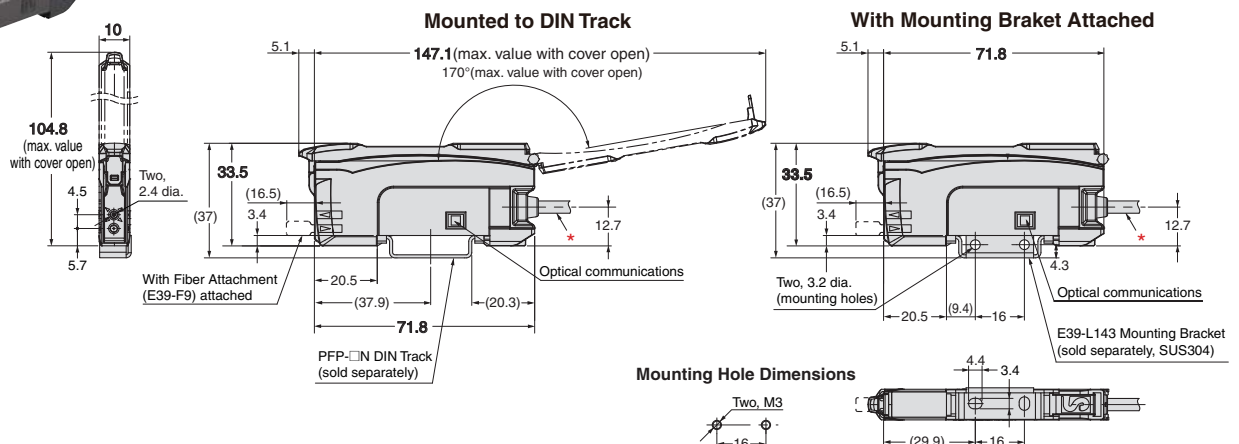

* Refer to the Fiber Sensor Best Selection Catalog (Cat No. E418) for the dimensions of models with wire-saving connectors, dimensions of models for Sensor Communications Units, and other dimensions.

NEW Introduction to New Fiber Units

A New Standard: **Build-in Lens** Series

Hex Shape
E32-LT11N
E32-LD11N

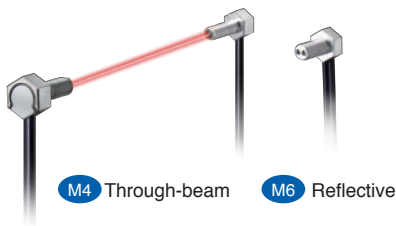

Straight Type
E32-LT11 (R)
E32-LD11 (R)

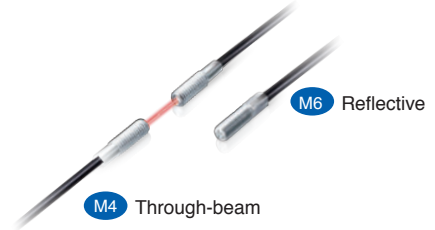

Flat Models
E32-LT35Z

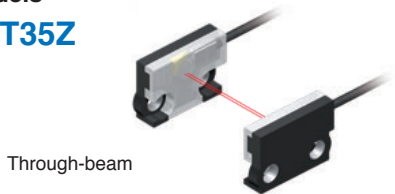

Oil-resistant
E32-T11NF

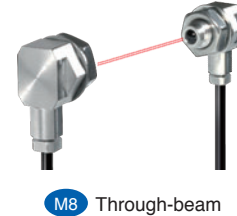

Fiber Sensor Best Selection Catalog

Refer to the Fiber Sensor Best Selection Catalog for information on the above Fiber Units and detailed information on the E3NX-FA.

Cat. No. E418



Compliance with International Standards



* Only the E3NX-FA11, E3NX-21, E3NX-41 and E3NX-51 are certified for UL standards.

EtherCAT® is a registered trademark and patented technology, licensed by Beckhoff Automation GmbH, Germany.

CompoNet is a registered trademark of the ODVA.

CC-Link is a registered trademark of Mitsubishi Electric Corporation. The trademark is managed by the CC-Link Partner Association.

OMRON Corporation Industrial Automation Company
 Kyoto, JAPAN

Contact: www.ia.omron.com

Regional Headquarters

OMRON EUROPE B.V.
Sensor Business Unit
 Carl-Benz-Str. 4, D-71154 Nufringen, Germany
 Tel: (49) 7032-811-0/Fax: (49) 7032-811-199

OMRON ELECTRONICS LLC
 2895 Greenspoint Parkway, Suite 200
 Hoffman Estates, IL 60169 U.S.A.
 Tel: (1) 847-843-7900/Fax: (1) 847-843-7787

OMRON ASIA PACIFIC PTE. LTD.
 No. 438A Alexandra Road # 05-05/08 (Lobby 2),
 Alexandra Technopark,
 Singapore 119967
 Tel: (65) 6835-3011/Fax: (65) 6835-2711

OMRON (CHINA) CO., LTD.
 Room 2211, Bank of China Tower,
 200 Yin Cheng Zhong Road,
 PuDong New Area, Shanghai, 200120, China
 Tel: (86) 21-5037-2222/Fax: (86) 21-5037-2200

Authorized Distributor:

© OMRON Corporation 2012-2016 All Rights Reserved.
 In the interest of product improvement,
 specifications are subject to change without notice.

CSM_8_1_0916
Cat. No. E426-E1-04

0416(1212)