

Safety Key Selector Switch A22TK

Key-type Selector Switch with Direct Opening Mechanism

- Selector Switch for secure equipment activation during maintenance
- 30 types of exclusive keys make it more difficult to disable.
- The key has the same shape as the following keys.
 - The key of the A22LK Guard Lock Safety Key Selector Switch
 - The trapped key of the D4JL Guard Lock Safety-door Switch
 - The lockout key of the D4JL-NSK10-LK and D4GL-SK10-LK Slide Key Units
- Common to the switch part of Emergency Stop Switch A22E. (Non-lighted model only)



For the most recent information on models that have been certified for safety standards, refer to your OMRON website.

 Be sure to read the "Safety Precautions" on page 12.

Features

Because the A22TK Safety Key Selector Switch uses the same key as the Guard Lock Safety-door Switch, the operator is prevented from forgetting to remove the key. The result is a safer working environment when performing maintenance.

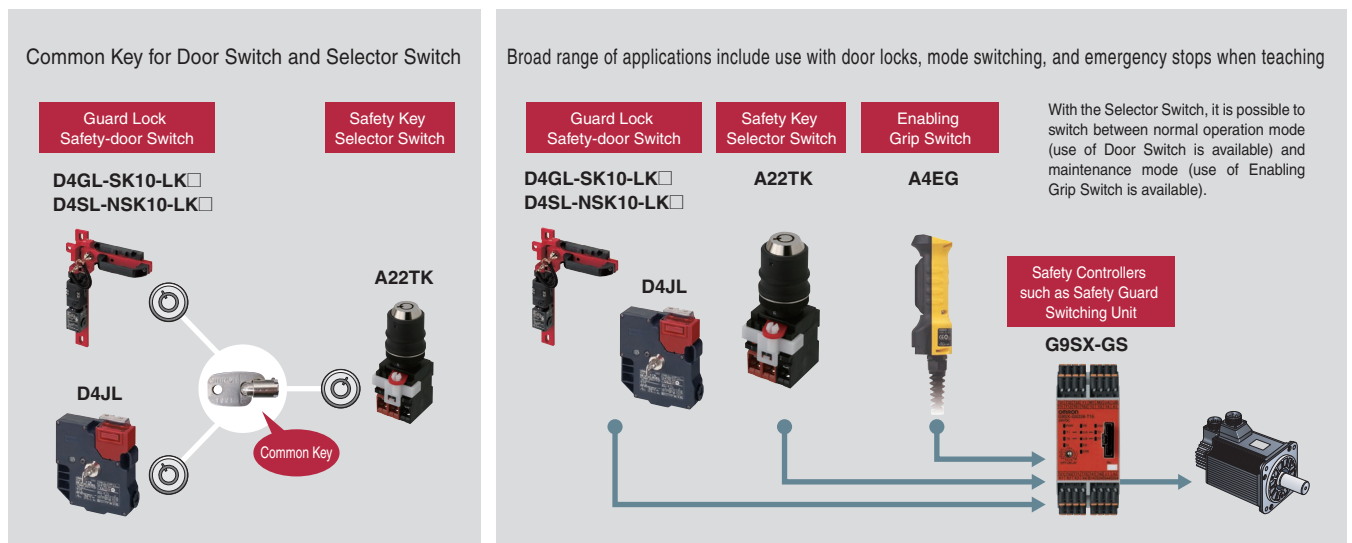

* To unify keys, specify the same key type.

From

Safety can be ensured, but there is a risk of human error occurring during operation.

Guard Lock Safety-door Switch only

When only the Door Switch is used, the operator is at risk of being shut inside the barrier if, for example, he/she forgets to remove the trapped key and a third party locks the door. The equipment may also be started up while the operator is inside.

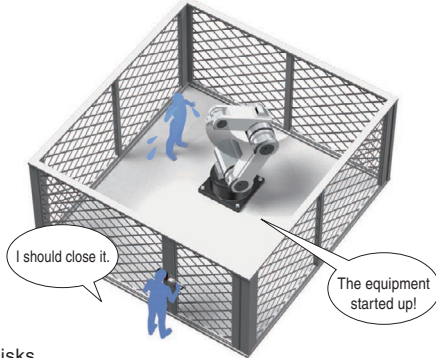

Assumed risks

- Forgetting to remove the key
- Being trapped inside
- Starting equipment

Guard Lock Safety-door Switch + **Key Selector Switch (A22K)**

The safety level is enhanced by switching to maintenance mode. However, because two different types of keys are required, the operator is still at risk of being shut inside if he/she forgets to remove the trapped key.

Different keys

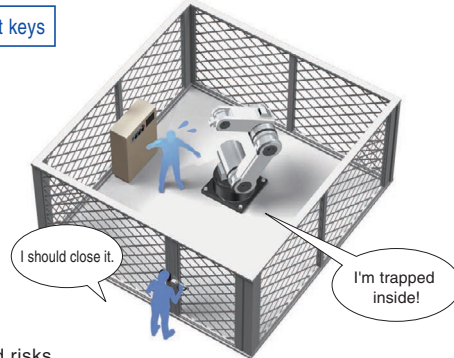

Assumed risks

- Forgetting to remove the key
- Being trapped inside

To

By using a common key, the risk of human error is reduced in operations from when the door is open/shut until the equipment is started.

Guard Lock Safety-door Switch + **Safety Key Selector Switch (A22TK)**

The two locks on the door and equipment use the same key, reducing the likelihood that the user will forget to remove it. In addition, the key cannot be removed when maintenance is being performed. This prevents the key from being lost and greatly reduces the risk of an operator becoming trapped inside. Same Key

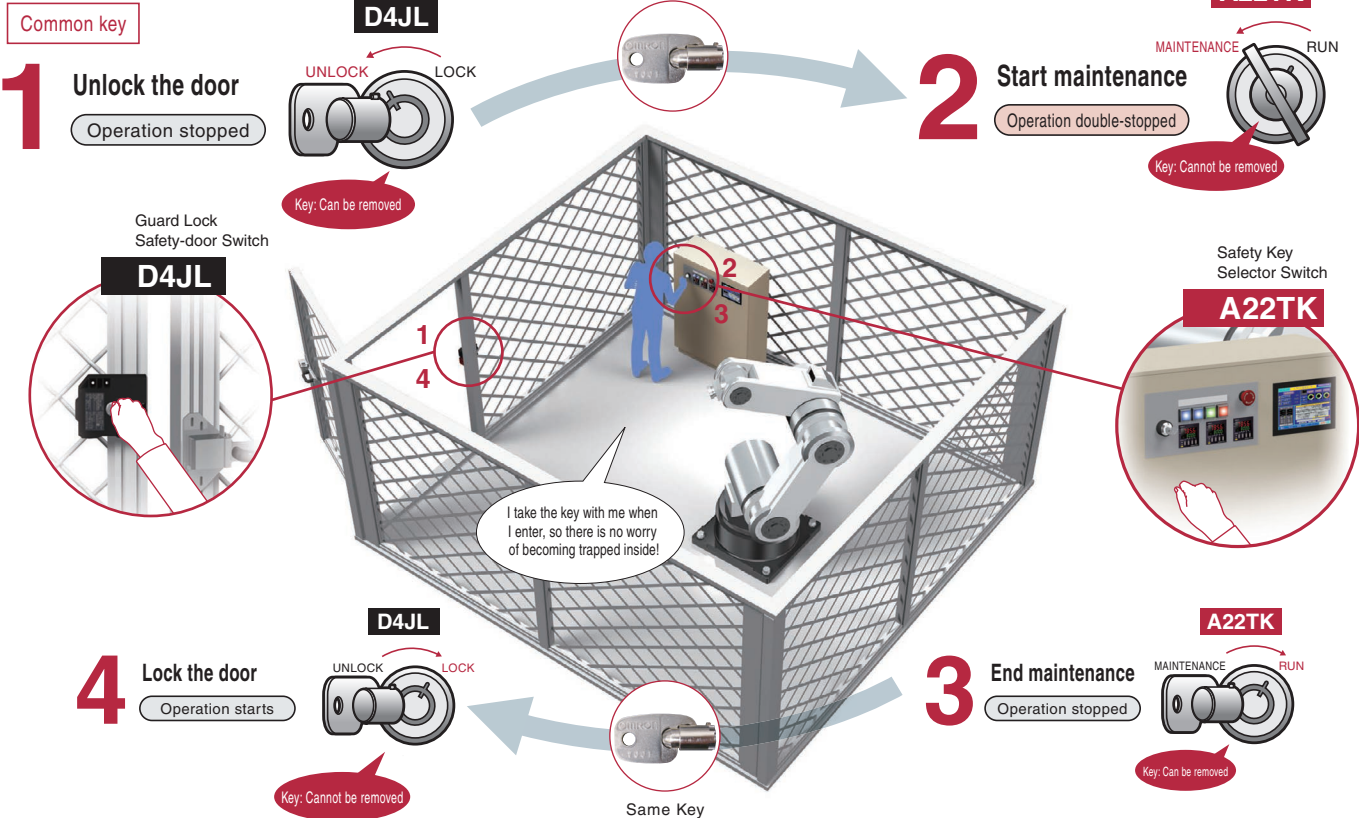

Furthermore

By using the **Enabling Grip Switch** during maintenance and by using a **Safety Laser Scanner** or **Safety Mat** to detect the presence of operators, equipment malfunctions can be prevented when operators are inside, enabling a higher safety level.

Model Number Structure

Model Number Legend (Ordering as a set)

The Operation Unit and Switch are delivered as a set. For information on combinations, refer to Ordering Information on page 5.

The models numbers of only Operation Units are they same as the set model numbers without (2) Contact Configuration.

Example: The model number of the Operation Unit from the A22TK-2LL-12-K01 Set is A22TK-2LL-K01.

Ask your OMRON representative about parts without model numbers when ordering.

A 2 2 T K - 2 L L - 1 2 - K 0 1

(1) Operation Unit

Symbol	No. of notches	Key release position	Key position of NC contact closing
2LL	2		
2RL			
2LR			
2RR			

(3) Key Availability

Symbol	Type
None	No key
K	With key

(4) Key Type

01 to 30: 30 types *

(2) Contact Configuration

Symbol	Type
01	SPST-NC
11	SPST-NO/SPST-NC
02	DPST-NC
12	DPST-NC + SPST-NO
21	DPST-NO + SPST-NC
03	TPST-NC

* Key can be created up to 30 types. Specify keys in order starting from 01.

Key drop preventive type

A 2 2 T K - - - 0 1 - S J

(1) (2) (3)

(1) Operation Unit

Symbol	No. of notches	Key release position	Key position of NC contact closing
2LL	2		
2RL			
2LR			
2RR			

(2) Contact Configuration

Symbol	Type
01	SPST-NC
11	SPST-NO/SPST-NC
02	DPST-NC
12	DPST-NC+SPST-NO
21	DPST-NO+SPST-NC
03	TPST-NC

(3) Key Availability

Symbol	Type
None	No key
K	With key

A22TK

Key drop preventive (on the A22TK-2RL-□)

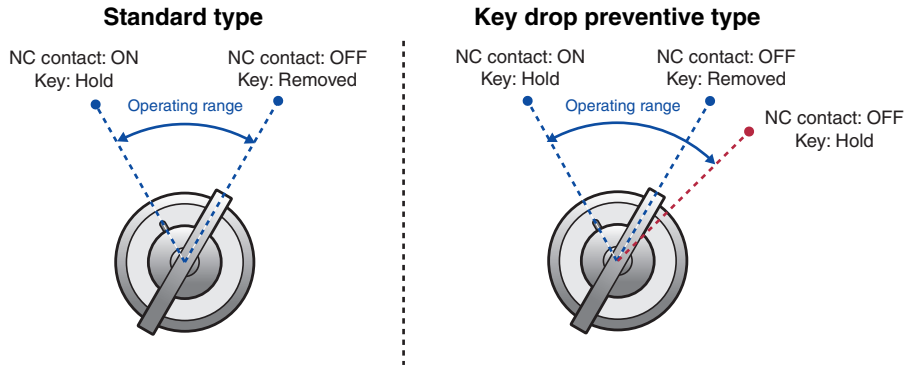

Contact Configuration

A22TK-2□L

Key position	SPST-NC	SPST-NO/SPST-NC	DPST-NC	DPST-NC + SPST-NO	DPST-NO + SPST-NO	TPST-NC

A22TK-2□R

Key position	SPST-NC	SPST-NO/SPST-NC	DPST-NC	DPST-NC + SPST-NO	DPST-NO + SPST-NO	TPST-NC

Operation Angle

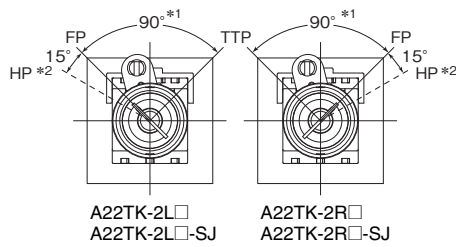

FP : Free position
 TTP : Total travel position
 HP : Key hold position (drop prevention) *2

*1. If the key is stopped at a position between FP and TTP, the contacts will not be in the states indicated above. Always be careful to turn the key completely to the FP (HP) or TTP position to ensure that the contacts are properly switched and the direct open circuit operation characteristics are obtained.

*2. Key drop preventive type (A22TK-□-SJ or A22TK-□-SJ only)







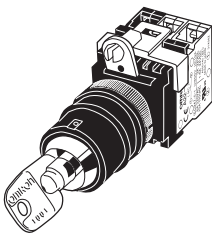
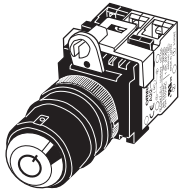



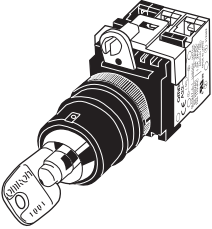



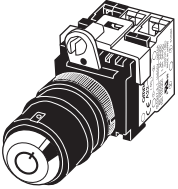

Ordering Information

Switch

List of Models (Completely Assembled)... Shipped as a set which includes the Operation Unit and Switch. The models numbers of only Operation Units are they same as the set model numbers without (2) Contact Configuration. Example: The model number of the Operation Unit from the A22TK-2LL-12-K01 Set is A22TK-2LL-K01. Ask your OMRON representative about parts without model numbers when ordering.

Appearance	Key release position	Key position of NC contact closing	Contact Configuration	Key availability	Model
	↙	↙	SPST-NC	Yes	A22TK-2LL-01-K01
			SPST-NO/SPST-NC		A22TK-2LL-11-K01
			DPST-NC		A22TK-2LL-02-K01
			DPST-NC + SPST-NO		A22TK-2LL-12-K01
			DPST-NO + SPST-NC		A22TK-2LL-21-K01
			TPST-NC		A22TK-2LL-03-K01
	↗	↙	SPST-NC		A22TK-2RL-01-K01
			SPST-NO/SPST-NC		A22TK-2RL-11-K01
			DPST-NC		A22TK-2RL-02-K01
			DPST-NC + SPST-NO		A22TK-2RL-12-K01
			DPST-NO + SPST-NC		A22TK-2RL-21-K01
			TPST-NC		A22TK-2RL-03-K01
	↙	↗	SPST-NC		A22TK-2LR-01-K01
			SPST-NO/SPST-NC		A22TK-2LR-11-K01
			DPST-NC		A22TK-2LR-02-K01
			DPST-NC + SPST-NO		A22TK-2LR-12-K01
			DPST-NO + SPST-NC		A22TK-2LR-21-K01
			TPST-NC		A22TK-2LR-03-K01
	↗	↗	SPST-NC		A22TK-2RR-01-K01
			SPST-NO/SPST-NC		A22TK-2RR-11-K01
			DPST-NC		A22TK-2RR-02-K01
			DPST-NC + SPST-NO		A22TK-2RR-12-K01
			DPST-NO + SPST-NC		A22TK-2RR-21-K01
			TPST-NC		A22TK-2RR-03-K01
	↙	↙	SPST-NC	No	A22TK-2LL-01-01
			SPST-NO/SPST-NC		A22TK-2LL-11-01
			DPST-NC		A22TK-2LL-02-01
			DPST-NC + SPST-NO		A22TK-2LL-12-01
			DPST-NO + SPST-NC		A22TK-2LL-21-01
			TPST-NC		A22TK-2LL-03-01
	↗	↙	SPST-NC		A22TK-2RL-01-01
			SPST-NO/SPST-NC		A22TK-2RL-11-01
			DPST-NC		A22TK-2RL-02-01
			DPST-NC + SPST-NO		A22TK-2RL-12-01
			DPST-NO + SPST-NC		A22TK-2RL-21-01
			TPST-NC		A22TK-2RL-03-01
	↙	↗	SPST-NC		A22TK-2LR-01-01
			SPST-NO/SPST-NC		A22TK-2LR-11-01
			DPST-NC		A22TK-2LR-02-01
			DPST-NC + SPST-NO		A22TK-2LR-12-01
			DPST-NO + SPST-NC		A22TK-2LR-21-01
			TPST-NC		A22TK-2LR-03-01
	↗	↗	SPST-NC		A22TK-2RR-01-01
			SPST-NO/SPST-NC		A22TK-2RR-11-01
			DPST-NC		A22TK-2RR-02-01
			DPST-NC + SPST-NO		A22TK-2RR-12-01
			DPST-NO + SPST-NC		A22TK-2RR-21-01
			TPST-NC		A22TK-2RR-03-01

A22TK

Appearance	Key release position	Key position of NC contact closing	Contact Configuration	Key availability	Model
			SPST-NC	Yes	A22TK-2LL-01-K01-SJ
			SPST-NO/SPST-NC		A22TK-2LL-11-K01-SJ
			DPST-NC		A22TK-2LL-02-K01-SJ
			DPST-NC + SPST-NO		A22TK-2LL-12-K01-SJ
			DPST-NO + SPST-NC		A22TK-2LL-21-K01-SJ
			TPST-NC		A22TK-2LL-03-K01-SJ
			SPST-NC		A22TK-2RL-01-K01-SJ
			SPST-NO/SPST-NC		A22TK-2RL-11-K01-SJ
			DPST-NC		A22TK-2RL-02-K01-SJ
			DPST-NC + SPST-NO		A22TK-2RL-12-K01-SJ
			DPST-NO + SPST-NC		A22TK-2RL-21-K01-SJ
			TPST-NC		A22TK-2RL-03-K01-SJ
			SPST-NC		A22TK-2LR-01-K01-SJ
			SPST-NO/SPST-NC		A22TK-2LR-11-K01-SJ
			DPST-NC		A22TK-2LR-02-K01-SJ
			DPST-NC + SPST-NO		A22TK-2LR-12-K01-SJ
			DPST-NO + SPST-NC		A22TK-2LR-21-K01-SJ
			TPST-NC		A22TK-2LR-03-K01-SJ
			SPST-NC		A22TK-2RR-01-K01-SJ
			SPST-NO/SPST-NC		A22TK-2RR-11-K01-SJ
			DPST-NC		A22TK-2RR-02-K01-SJ
			DPST-NC + SPST-NO		A22TK-2RR-12-K01-SJ
			DPST-NO + SPST-NC		A22TK-2RR-21-K01-SJ
			TPST-NC		A22TK-2RR-03-K01-SJ
			SPST-NC	No	A22TK-2LL-01-01-SJ
			SPST-NO/SPST-NC		A22TK-2LL-11-01-SJ
			DPST-NC		A22TK-2LL-02-01-SJ
			DPST-NC + SPST-NO		A22TK-2LL-12-01-SJ
			DPST-NO + SPST-NC		A22TK-2LL-21-01-SJ
			TPST-NC		A22TK-2LL-03-01-SJ
			SPST-NC		A22TK-2RL-01-01-SJ
			SPST-NO/SPST-NC		A22TK-2RL-11-01-SJ
			DPST-NC		A22TK-2RL-02-01-SJ
			DPST-NC + SPST-NO		A22TK-2RL-12-01-SJ
			DPST-NO + SPST-NC		A22TK-2RL-21-01-SJ
			TPST-NC		A22TK-2RL-03-01-SJ
			SPST-NC		A22TK-2LR-01-01-SJ
			SPST-NO/SPST-NC		A22TK-2LR-11-01-SJ
			DPST-NC		A22TK-2LR-02-01-SJ
			DPST-NC + SPST-NO		A22TK-2LR-12-01-SJ
			DPST-NO + SPST-NC		A22TK-2LR-21-01-SJ
			TPST-NC		A22TK-2LR-03-01-SJ
			SPST-NC		A22TK-2RR-01-01-SJ
			SPST-NO/SPST-NC		A22TK-2RR-11-01-SJ
			DPST-NC		A22TK-2RR-02-01-SJ
			DPST-NC + SPST-NO		A22TK-2RR-12-01-SJ
			DPST-NO + SPST-NC		A22TK-2RR-21-01-SJ
			TPST-NC		A22TK-2RR-03-01-SJ

Accessories

Name	Appearance	Classification	Model	Remarks
Control Box		One hole, yellow box	A22Z-B101Y	Material: Polycarbonate resin The A22Z-B101Y do not support 2NO, 2NC, or 1NO + 1NC One-piece Switch Blocks. The A22Z-B201Y do not support A22-series Alternate-action Switches. They also do not support 2NO, 2NC, or 1NO + 1NC One-piece Switch Blocks.
			A22Z-B201Y	

Note: For information on two-hole and three-hole control boxes, contact your OMRON representative.
The Switch Block, Mounting Latch, Connector, and Lock Plate of A22E can be used.

Specifications

Approved Standard Ratings

- UL, cUL (File No. E41515): 6 A at 220 VAC, 10 A at 110 VAC
- TÜV (EN60947-5-1) (Low Voltage Directive): 3 A at 220 VAC
- CCC (GB14048.5): 3 A at 240 VAC, 1.5 A at 24 VDC

Certified Standards

Certification body	Standards	File No.
UL *1	UL508, C22.2 No.14	E41515
TÜV SÜD	EN60947-5-1 (certified direct opening mechanism)	Consult your OMRON representative for details.
CQC(CCC)	GB14048.5	
KOSHA	EN60947-5-1	

Note: Only models with NC contacts have a direct opening mechanism.

*1. UL-certification for CSA C22.2 No. 14 has been obtained. (Certification has been obtained for the Switch Unit only)

Ratings

Contacts (Standard load)

Rated carry current (A)	Rated voltage (V)	Rated current (A)					
		AC15 (inductive load)	AC12 (resistive load)	DC13 (inductive load)	DC12 (resistive load)		
10	24 VAC	10	10	-	-		
	110	5	10				
	220	3	6				
	380	2	3				
	440	1	2	1.5	10		
	24 VDC	-	-			0.5	2
	110					0.2	0.6
	220					0.1	0.2
380							

Note: 1. Rated current values are determined according to the testing conditions. The above ratings were obtained by conducting tests under the following conditions.

- (1) Ambient temperature: 20±2°C
- (2) Ambient humidity: 65±5% RH
- (3) Operating frequency: 20 operations/minute

2. Minimum applicable load: 10 mA at 5 VDC

Characteristics

Item	Model	A22TK
Allowable operating frequency	Mechanical	30 operations/minute max.
	Electrical	30 operations/minute max.
Insulation resistance		100 MΩ min. (at 500 VDC)
Dielectric strength	Between terminals of same polarity	2,500 VAC, 50/60 Hz for 1 min.
	Between each terminal and ground	2,500 VAC, 50/60 Hz for 1 min.
Vibration resistance *1		10 to 55 Hz, 1.5-mm double amplitude (within 1 ms)
Shock resistance	Destruction	1000 m/s ²
	Malfunction *1	250 m/s ² max.
Durability	Mechanical	100,000 operations min.
	Electrical	100,000 operations min.
Ambient operating temperature *2		-20 to +70°C
Ambient operating humidity		35% to 85%RH
Ambient storage temperature		-40 to +70°C
Degree of protection		IP65 *3
Electric shock protection class		Class II
PTI (tracking characteristic)		175
Degree of contamination		3 (EN60947-5-1)

*1. Malfunction within 1 ms.

*2. With no icing or condensation.

*3. The degree of protection from the front of the panel.

Note: 1. Do not allow the load current to exceed the rated value.

2. The contact ON/OFF timing is not synchronized. Confirm performance before application.

3. Once the contacts have been used to switch a load, however, they cannot be used to switch smaller loads. The contact surfaces will become rough once they have been used and contact reliability for smaller loads may be reduced.

Structure and Nomenclature

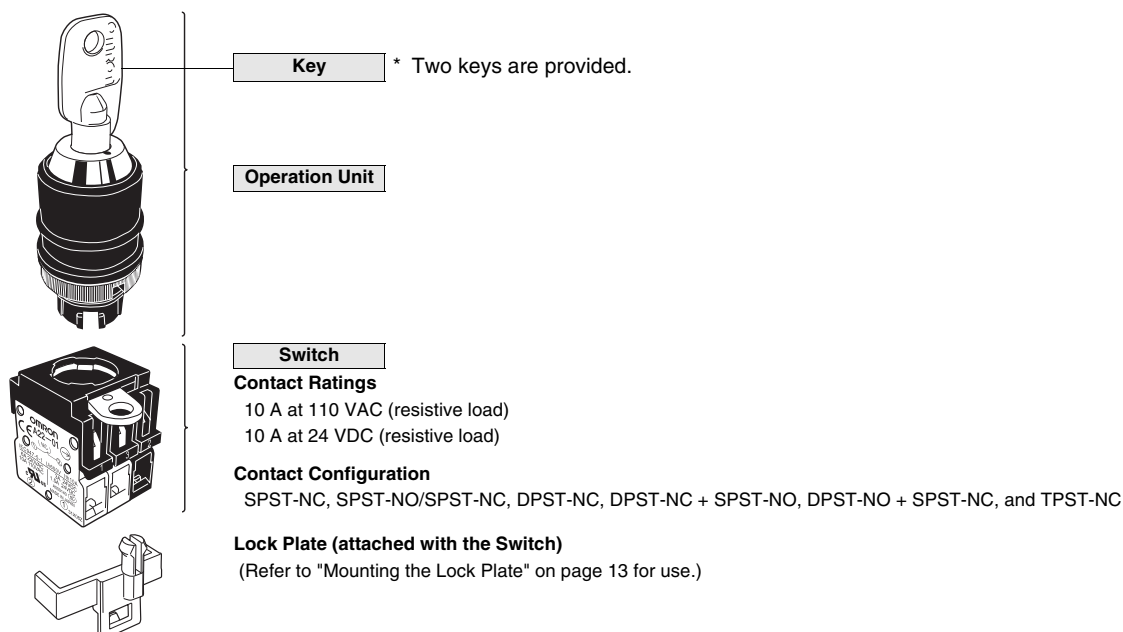

(The above figures are examples of the model with key.)

A22TK

Dimensions

(Unit: mm)

● Switch

A22TK-2LL

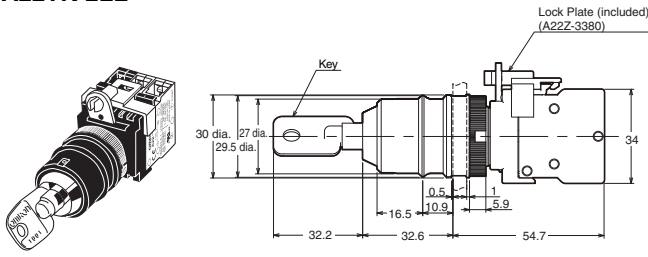

A22TK-2RL

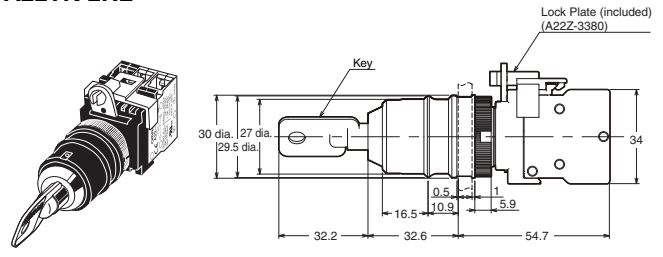

● Accessories

Control Box

A22Z-B101Y (1 hole)

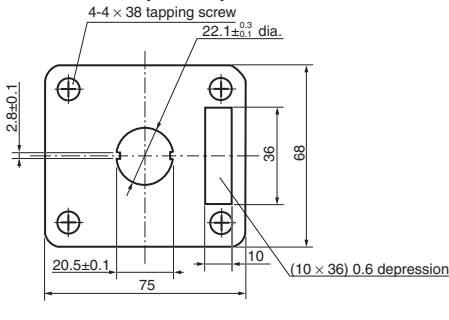

Cable Draw-out Hole (Top View)

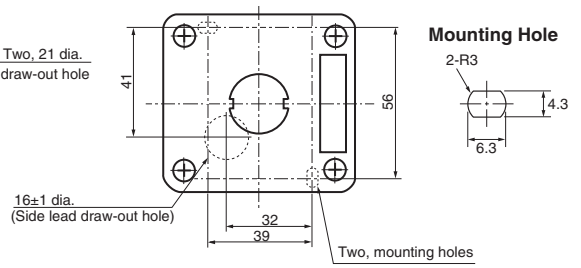

Control Box

A22Z-B201Y (1 hole)

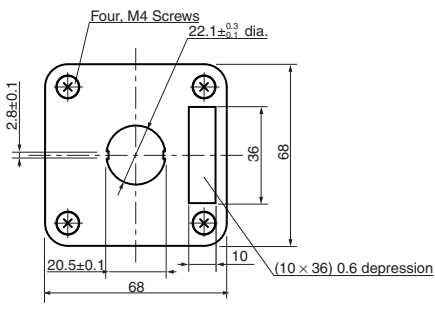

Cable Draw-out Hole (Top View)

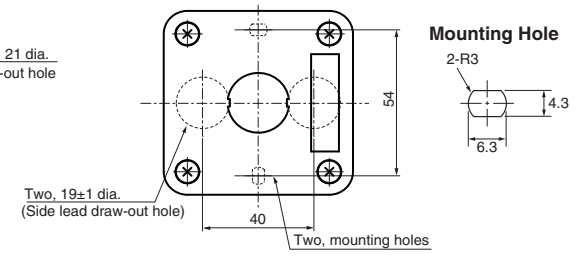

Terminal Arrangement (Bottom View)

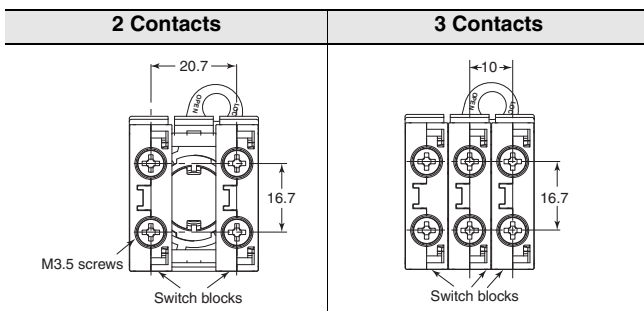

Terminal Connection



Type	Terminal connection (Bottom View)				
	SPST-NO/SPST-NC	DPST-NC	DPST-NC + SPST-NO	DPST-NO + SPST-NC	TPST-NC
Non-lighted					

Installation

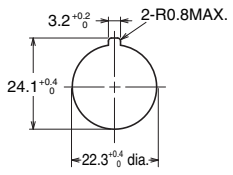
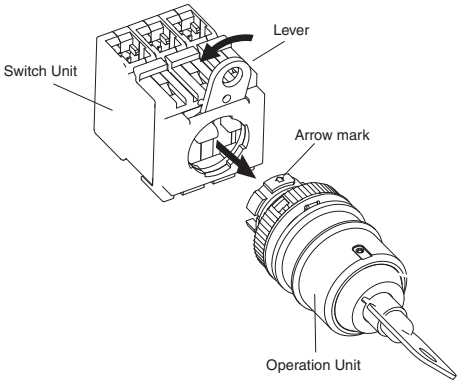
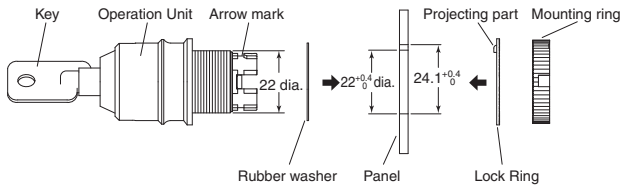
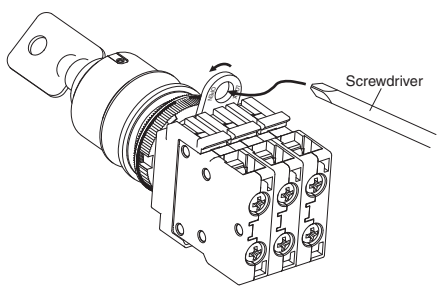
Mounting to the Panel

(1) Preparing the Panel	(3) Mounting the Switch on the Operation Unit
<ul style="list-style-type: none"> The panel dimensions are shown below. Recommended panel thickness: 1 to 5 mm.  <ul style="list-style-type: none"> A Lock Ring is provided as a standard feature. When painting or coating the panel, make sure that the specified panel dimensions apply to the panel after painting or coating. 	<ul style="list-style-type: none"> Insert the Operation Unit into the Switch Unit, aligning the arrow mark inscribed on the Case with the lever on the Switch Blocks, then move the lever in the direction indicated by the arrow in the following figure. 
(2) Mounting the Operation Unit on the Panel	(4) Removing the Switch
<ul style="list-style-type: none"> Insert the Operation Unit from the front surface of the panel, insert the Lock Ring and the mounting ring from the terminal side, then tighten the ring. Before tightening, check that the rubber washer is present between the Operation Unit and the panel. Tighten the mounting ring at a torque of 0.98 to 1.96 N-m. When using a Lock Ring, insert the projecting part into the lock slot, and then tighten the mounting ring. 	<ul style="list-style-type: none"> Move the lever in the direction indicated by the arrow in the following figure, then pull the Operation Unit or the Switch Blocks. Since the lever has a hole with an inside diameter of 6.5 mm, the lever can be moved in the specified direction by inserting a screwdriver into the hole and then moving the screwdriver. 

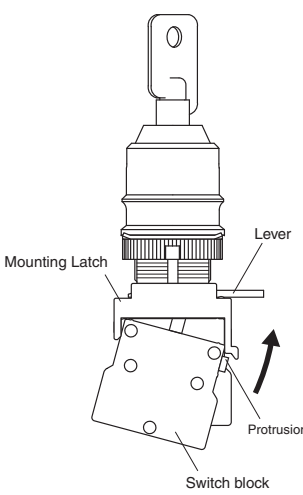
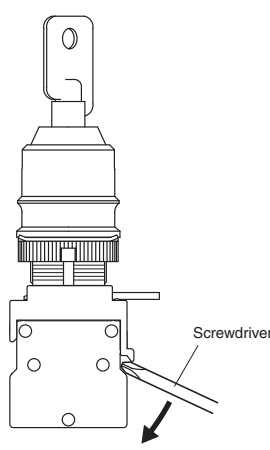
Installing/Removing the Switch Blocks

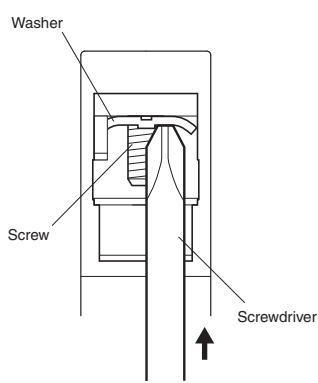
(1) Installing the Switch Blocks	(2) Removing the Switch Blocks	Wiring
<ul style="list-style-type: none"> Hook the small protrusion on the Mounting Latch into the groove on the other side of the lever, then push up the Switch Block in the direction indicated by the arrow in the figure below. 	<ul style="list-style-type: none"> Insert a screwdriver between the Mounting Latch and the Switch Block, then push down the screwdriver in the direction indicated by the arrow in the following figure.  <p>Use either of the following screwdrivers.</p> <ul style="list-style-type: none"> Flat-head screwdriver 3 to 6 mm Phillips screwdriver 3 to 6 mm dia. 	<ul style="list-style-type: none"> Loosen the terminal screw from the Switch Unit until it completely comes off the groove, insert a screwdriver as shown in the following figure, then push up the washer in the direction indicated by the arrow to temporarily secure it. Now, a round crimp terminal can be connected. After inserting the terminal, tighten the screws to complete wiring. 

Application Examples

Highest achievable PL/ safety category	Model	Stop category	Reset
PLe/4 equivalent	A22TK-□-11-□□ Safety Key Selector Switch D4NL / D4SL-N / D4JL Guard Lock Safety-door Switch (Mechanical Lock Type) D4N / D4F Safety Limit Switch A4EG Enabling Grip Switch G9SX-GS226-T15 Safety Guard Switching Unit G9SX-BC202 Flexible Safety Unit	0	Manual

Note: The above PL is only the evaluation result of the example. The PL must be evaluated in an actual application by the customer after confirming the usage conditions.

●Application Overview

1. When the emergency stop switch S1 is pressed.

- The power supply to the motor M1 and M2 is turned OFF immediately when the emergency stop switch S1 is pressed.
- The power supply to the motor M1 is kept OFF until the reset switch S2 is pressed while the emergency stop switch S1 is released.
- When normal operating mode (M1 = ON, M2 = OFF) is selected on the selector switch S8, the power supply to the motor M2 is kept OFF until the guard is closed and the reset switch S2 and S7 are pressed while the emergency stop switch S1 is released.
- When maintenance mode (M1 = OFF, M2 = ON) is selected on the selector switch S8, the power supply to the motor M2 is kept OFF until the enabling switch is gripped to the middle position and the reset switch S2 and S7 are pressed while the emergency stop switch S1 is released.

2. Normal operating mode (the emergency stop switch S1 is released)

- Normal operating mode (M1 = ON, M2 = OFF) is selected on the selector switch S8. The enabling switch S3 is disabled.
- Power is supplied to motor M2 when the guard is closed.
- When the lock release switch S5 is pressed after the motor M2 is stopped, the guard lock is released and the guard is opened. Opening of the guard is detected by S4 and S6, and the power supply to the motor M2 is turned OFF immediately (The power supply to the motor M1 is kept ON).
- The power supply to the motor M2 is kept OFF until the guard is closed and the reset switch S7 is pressed.

3. Maintenance mode (the emergency stop switch S1 is released)

- Maintenance mode (M1 = OFF, M2 = ON) is selected on the selector switch S8 after the motor M2 is stopped. S4 and S6 for detecting the opening and closing of the guard are disabled.
- The guard is opened after the lock release switch S5 is pressed and the guard lock is released.
- The power supply to the motor M2 is turned ON while the enabling switch is gripped to the middle position.
- If the enabling switch is released or gripped past the middle position, the power supply to the motor M2 is turned OFF immediately.
- The power supply to the motor M2 is kept OFF until the enabling switch is gripped again to the middle position and the reset switch S7 is pressed.

●Circuit Diagram

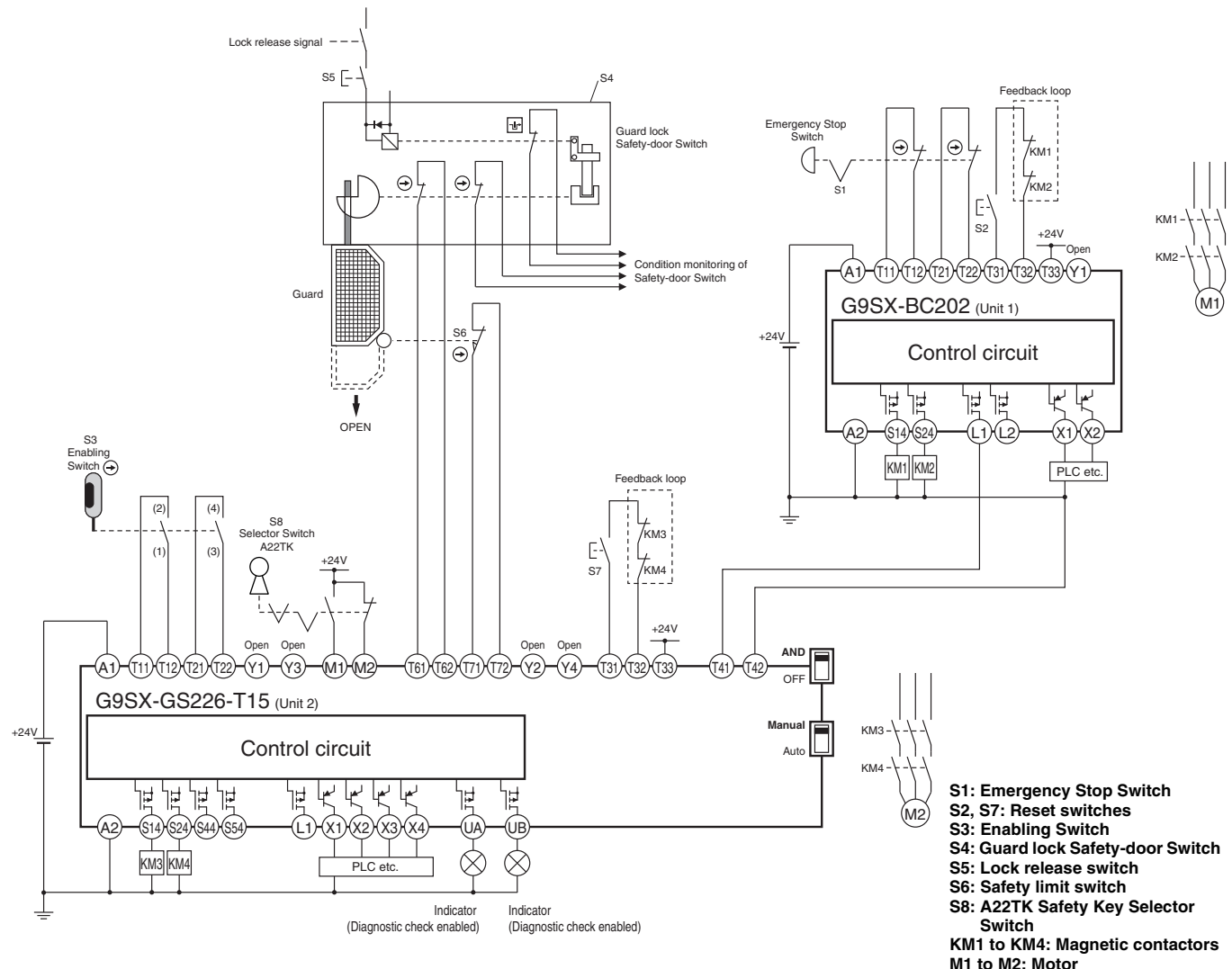

Timing Chart

<G9SX-BC202(Unit 1)>

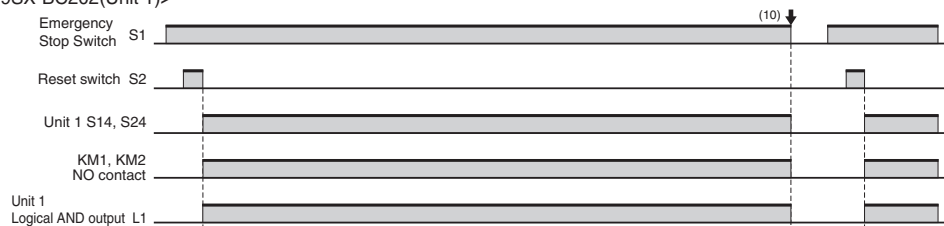

<G9SX-GS226-T15(Unit 2)>

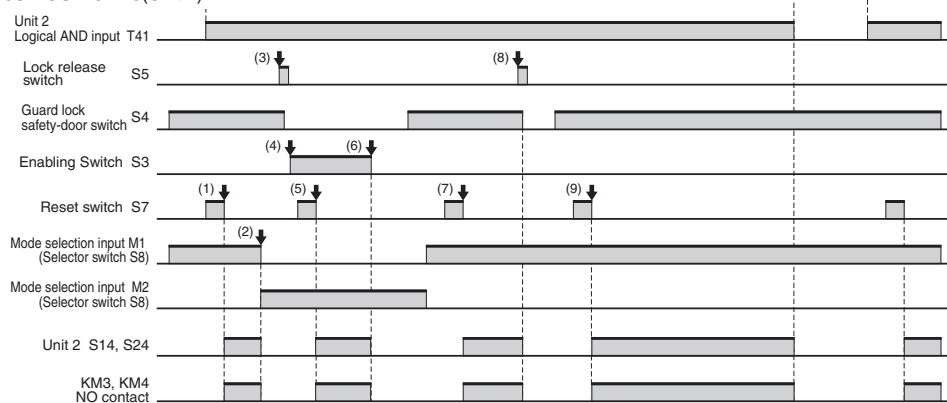



- (1) Start the unit 2 in normal operating mode.
- (2) Switch to maintenance mode by operating the selector switch.
- (3) After checking that the motor has stopped, press the lock release switch to release the guard lock, and open the door to perform maintenance.
- (4) Grip the enabling switch to the middle position.
- (5) Press the reset switch to start the unit 2 in maintenance mode.
- (6) Release (or grip) the enabling switch to stop the unit 2.
- (7) After closing the guard and switching to operating mode by operating the selector switch, press the reset switch to restart the unit 2.
- (8) After checking that the motor has stopped after a stop signal is input during operating mode, press the lock release switch and open the guard to stop the unit 2.
- (9) Close the guard and press the reset switch to restart the unit 2.
- (10) Operate the emergency stop switch -> All the units stop.

Safety Precautions

Be sure to read the precautions for **All Pushbutton Switches** in the website at: <http://www.ia.omron.com/>.

Indication and Meaning for Safe Use

 DANGER	Indicates an imminently hazardous situation which, if not avoided, is likely to result in serious injury or may result in death. Additionally there may be severe property damage.
 CAUTION	Indicates a potentially hazardous situation which, if not avoided, may result in minor or moderate injury or in property damage.
Precautions for Safe Use	Supplementary comments on what to do or avoid doing, to use the product safely.
Precautions for Correct Use	Supplementary comments on what to do or avoid doing, to prevent failure to operate, or undesirable effect on product performance.

 **DANGER**

Always confirm that safety functions are operational before starting operation. Wiring mistakes, setting mistakes, switch failure or other factors may prevent safety functions from operating. This may result in the machine continuing to operate, possibly resulting in human accidents. 

 **CAUTION**

If the Operation Unit is separated from the Socket Unit, the equipment will not stop, creating a hazardous condition. Secure the lever on the Socket Unit by using the A22Z-3380 Lock Plate so that the Operation Unit cannot be easily separated from the Socket Unit. 

(Refer to "Mounting the Lock Plate" at the right.)

[Used in combination with a Slide Key]
The machine may operate, possibly causing injury. Do not disable safety function by using a spare door switch operation key or spare key with the door open. 

[Used outside/inside hazardous area]
The machine may operate, possibly causing injury. Do not disable safety function by using a spare key outside or inside the hazardous area. 

Precautions for Safe Use

Installation Environment

- Do not use the switch in locations where explosive or flammable gasses may be present.
- Do not use the switch submerged in oil or water or in locations continuously subject to splashes of oil or water. Doing so may result in oil or water entering the switch.

Wiring

- Connect a fuse in series with the A22TK to protect it from shortcircuit damage. The value of the breaking current of the fuse must be calculated by multiplying the rated current by 150% to 200%.
When using the A22TK for an EN rating, use a 10-A fuse of type gI or gG that complies with IEC 60269.
- Always make sure that the power is turned OFF before wiring the Switch.
Also, do not touch the terminals or other current-carrying ports while power is being supplied.
- Check the contact specifications before mounting the Switch Block. Use an NC contact for a safety circuit. It may not operate properly. Check the Switch Block for safe operation before use.
- Check the operating specification before mounting the Operation Unit. It may not operate properly. Check the Operation Unit for safe operation before use.

Installation

- Do not drop the Switch. Doing so may prevent the Switch from functioning to its full capability.
- Make sure the Switch is mounted securely to prevent it from falling off. Otherwise injury may result.
- Mount the Operation Key so that it will not come into contact with persons in the area when the door is opened and closed. Injury may result.
- Do not use a Switch as a stopper. Otherwise, the switch may be damaged and may not operate properly.
- Be sure to use the supplied Lock Ring. Otherwise, the switch may rotate and may not operate properly.

Others

- Do not attempt to disassemble or modify the Switch. Doing so may cause the Switch to malfunction.
- The durability of the Switch is greatly influenced by the switching conditions. Always test the switch under actual working conditions before application and use it in a switching circuit for which there are no problems with performance.
- The user must not maintain or repair equipment incorporating the Switch. Contact the manufacturer of the equipment for any maintenance or repairs required.

Precautions for Correct Use

Operating Environment

- This Switch is designed for use indoors. Using the Switch outdoors may damage it.
- Do not use the Switch where corrosive gases (e.g., H₂S, SO₂, NH₃, HNO₃, or Cl₂) are present or in locations subject to high temperature and humidity. Doing so may result in damage to the Switch as a result of contact failure or corrosion.
- Do not use the Switch in any of the following locations.
 - Locations subject to extreme temperature changes
 - Locations subject to high humidity or condensation
 - Locations subject to excessive vibration
 - Locations where metal dust, processing waste, oil, or chemicals may enter through the protective door
 - Locations subject to detergents, thinners, or other solvents

Storage

- Do not store the Switch where corrosive gases (e.g., H₂S, SO₂, NH₃, HNO₃, or Cl₂) or dust is present, or in locations subject to high temperature or high humidity.

Mounting

- Do not tighten the mounting ring more than necessary using tools such as pointed-nose pliers. Doing so will damage the mounting ring. The tightening torque is 0.98 to 1.96 N·m.
- Recommended panel thickness: 1 to 5 mm.

Mounting the Lock Plate

1. Confirm that the lever on the Mounting Latch is on the side where the Operation Unit is secured and then insert the protrusion on the Lock Plate into the hole in the lever on the Mounting Latch.
2. Press the hole on the Lock Plate onto the protrusion on the Mounting Latch until it clicks into place.
After mounting the Lock Plate, check that the lever does not move.

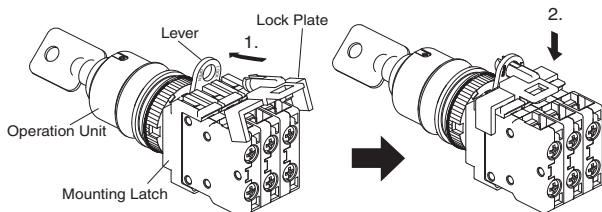

Operating the Key

- When rotating the key to the total travel position or free position, the operating force must be 1.47 N·m max.

Wiring

- Terminal screws must be Phillips or slotted M3.5 screws with a square washer.
- The tightening torque is 1.08 to 1.27 N·m.
- Single wires, stranded wires, and crimp terminals can be connected to the Switch
- Applicable Wiring Materials:
Twisted strands: 2 mm² max.
Solid wire: 1.6 mm dia. max.

Naked Crimp Terminals

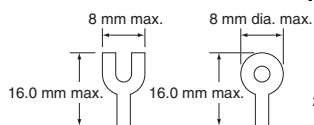

Crimp Terminals with Insulating Sheaths

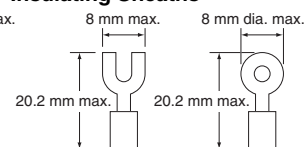

- After wiring the Switch, maintain an appropriate clearance and creepage distance.
- Do not pull the lead wires with excessive force. Doing so may disconnect them.
- The cable cannot be bended repeatedly.
- When bending the cable, provide a bending radius of 45 mm min. so as not to damage the cable insulation or sheath. Excessive bending may cause fire or leakage current.

Operating Environment

- The IP65 model is designed with a protective structure so that it will not sustain damage if it is subjected to water from any direction to the front of the panel.
- The Switch is intended for indoor use only. Using the Switch outdoor may cause it to fail.

Using the Microload

Contact failure may occur if a Switch designed for a standard load is used to switch a microload. Use Switches within the application ranges shown in the following graph. Even within the application range, insert a contact protection circuit, if necessary, to prevent the reduction of life expectancy due to extreme wear on the contacts caused by loads where inrush current occurs when the contact is opened and closed.

The minimum applicable load is the N-level reference value. This value indicates the malfunction reference level for the reliability level of 60% ($\lambda 60$) (conforming to JIS C5003).

The equation, $\lambda 60 = 0.5 \times 10^{-6}/\text{time}$ indicates that the estimated malfunction rate is less than 1/2,000,000 with a reliability level of 60%.

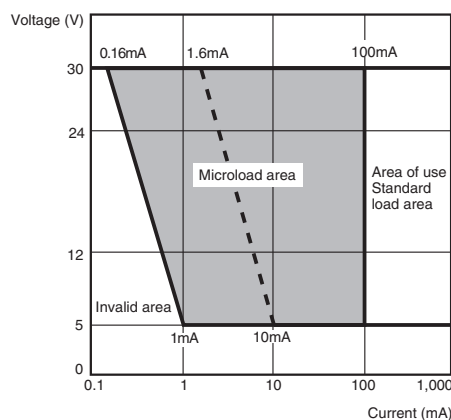

Others

- If the panel is to be coated, make sure that the panel meets the specified dimensions after coating.
- Due to the structure of the Switch, severe shock or vibration may cause malfunctions or damage to the Switch.
Also, most Switches are made from resin and will be damaged if they come into contact with sharp objects. Particularly scratches on the Operation Unit may create visual and operational obtrusions.
Handle the Switches with care, and do not throw or drop them.

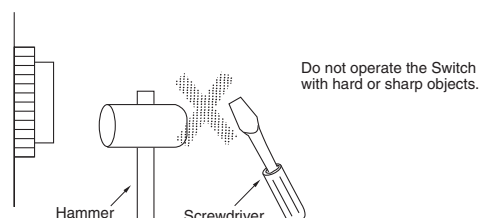
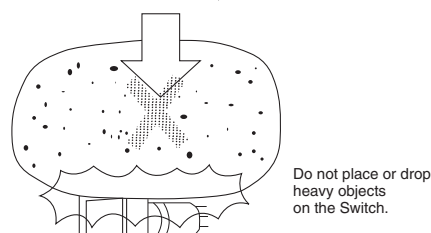
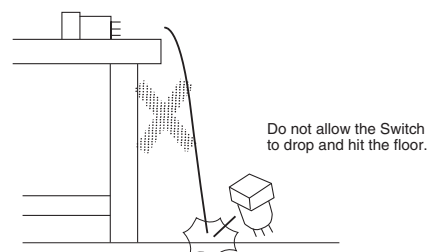

- Perform maintenance inspections periodically.
- Do not use the key switch to stop/start the machine.
- Mode switching by key must be performed by the operator specified in the operating manual.
- Apply load current not to exceed the rated value.
- The contact ON/OFF timing is not synchronized. Confirm performance before application.

Terms and Conditions Agreement

Read and understand this catalog.

Please read and understand this catalog before purchasing the products. Please consult your OMRON representative if you have any questions or comments.

Warranties.

- (a) Exclusive Warranty. Omron's exclusive warranty is that the Products will be free from defects in materials and workmanship for a period of twelve months from the date of sale by Omron (or such other period expressed in writing by Omron). Omron disclaims all other warranties, express or implied.
- (b) Limitations. OMRON MAKES NO WARRANTY OR REPRESENTATION, EXPRESS OR IMPLIED, ABOUT NON-INFRINGEMENT, MERCHANTABILITY OR FITNESS FOR A PARTICULAR PURPOSE OF THE PRODUCTS. BUYER ACKNOWLEDGES THAT IT ALONE HAS DETERMINED THAT THE PRODUCTS WILL SUITABLY MEET THE REQUIREMENTS OF THEIR INTENDED USE.

Omron further disclaims all warranties and responsibility of any type for claims or expenses based on infringement by the Products or otherwise of any intellectual property right. (c) Buyer Remedy. Omron's sole obligation hereunder shall be, at Omron's election, to (i) replace (in the form originally shipped with Buyer responsible for labor charges for removal or replacement thereof) the non-complying Product, (ii) repair the non-complying Product, or (iii) repay or credit Buyer an amount equal to the purchase price of the non-complying Product; provided that in no event shall Omron be responsible for warranty, repair, indemnity or any other claims or expenses regarding the Products unless Omron's analysis confirms that the Products were properly handled, stored, installed and maintained and not subject to contamination, abuse, misuse or inappropriate modification. Return of any Products by Buyer must be approved in writing by Omron before shipment. Omron Companies shall not be liable for the suitability or unsuitability or the results from the use of Products in combination with any electrical or electronic components, circuits, system assemblies or any other materials or substances or environments. Any advice, recommendations or information given orally or in writing, are not to be construed as an amendment or addition to the above warranty.

See <http://www.omron.com/global/> or contact your Omron representative for published information.

Limitation on Liability; Etc.

OMRON COMPANIES SHALL NOT BE LIABLE FOR SPECIAL, INDIRECT, INCIDENTAL, OR CONSEQUENTIAL DAMAGES, LOSS OF PROFITS OR PRODUCTION OR COMMERCIAL LOSS IN ANY WAY CONNECTED WITH THE PRODUCTS, WHETHER SUCH CLAIM IS BASED IN CONTRACT, WARRANTY, NEGLIGENCE OR STRICT LIABILITY.

Further, in no event shall liability of Omron Companies exceed the individual price of the Product on which liability is asserted.

Suitability of Use.

Omron Companies shall not be responsible for conformity with any standards, codes or regulations which apply to the combination of the Product in the Buyer's application or use of the Product. At Buyer's request, Omron will provide applicable third party certification documents identifying ratings and limitations of use which apply to the Product. This information by itself is not sufficient for a complete determination of the suitability of the Product in combination with the end product, machine, system, or other application or use. Buyer shall be solely responsible for determining appropriateness of the particular Product with respect to Buyer's application, product or system. Buyer shall take application responsibility in all cases.

NEVER USE THE PRODUCT FOR AN APPLICATION INVOLVING SERIOUS RISK TO LIFE OR PROPERTY OR IN LARGE QUANTITIES WITHOUT ENSURING THAT THE SYSTEM AS A WHOLE HAS BEEN DESIGNED TO ADDRESS THE RISKS, AND THAT THE OMRON PRODUCT(S) IS PROPERLY RATED AND INSTALLED FOR THE INTENDED USE WITHIN THE OVERALL EQUIPMENT OR SYSTEM.

Programmable Products.

Omron Companies shall not be responsible for the user's programming of a programmable Product, or any consequence thereof.

Performance Data.

Data presented in Omron Company websites, catalogs and other materials is provided as a guide for the user in determining suitability and does not constitute a warranty. It may represent the result of Omron's test conditions, and the user must correlate it to actual application requirements. Actual performance is subject to the Omron's Warranty and Limitations of Liability.

Change in Specifications.

Product specifications and accessories may be changed at any time based on improvements and other reasons. It is our practice to change part numbers when published ratings or features are changed, or when significant construction changes are made. However, some specifications of the Product may be changed without any notice. When in doubt, special part numbers may be assigned to fix or establish key specifications for your application. Please consult with your Omron's representative at any time to confirm actual specifications of purchased Product.

Errors and Omissions.

Information presented by Omron Companies has been checked and is believed to be accurate; however, no responsibility is assumed for clerical, typographical or proofreading errors or omissions.

OMRON Corporation Industrial Automation Company
Kyoto, JAPAN

Contact: www.ia.omron.com

Regional Headquarters

OMRON EUROPE B.V.

Wegalaan 67-69, 2132 JD Hoofddorp
The Netherlands
Tel: (31)2356-81-300/Fax: (31)2356-81-388

OMRON ELECTRONICS LLC

2895 Greenspoint Parkway, Suite 200
Hoffman Estates, IL 60169 U.S.A.
Tel: (1) 847-843-7900/Fax: (1) 847-843-7787

OMRON ASIA PACIFIC PTE. LTD.

No. 438A Alexandra Road # 05-05/08 (Lobby 2),
Alexandra Technopark,
Singapore 119967
Tel: (65) 6835-3011/Fax: (65) 6835-2711

OMRON (CHINA) CO., LTD.

Room 2211, Bank of China Tower,
200 Yin Cheng Zhong Road,
PuDong New Area, Shanghai, 200120, China
Tel: (86) 21-5037-2222/Fax: (86) 21-5037-2200

Authorized Distributor:

© OMRON Corporation 2009-2017 All Rights Reserved.
In the interest of product improvement,
specifications are subject to change without notice.

CSM_9_1_0917

Cat. No. **A189-E1-02**

0917 (0409)